

*Hardware for Professionals*

**hepo**

A Hettich & Poddar JV

hepo

*Price List w.e.f. January 2020*



# Index



## Distribution Products

Price List w.e.f. January 2020

Screw	
Hepo	Page No.
Zinc CSK Regular Thread Screw	05
Zinc Pan Head Regular Thread Screw	05
Stainless Steel (SS 304) CSK Regular Thread Screw	05
Self-Drilling Screw with Rib	06
Self-Tapping CSK Screw	06
Self-Tapping Pan Head Screw	06
Hexagonal Head Self Drilling Screw with Washer	06
Drywall Screw	06
Blackodised CSK Regular Thread Screw	07
Blackodised Pan Head Regular Thread Screw	07
Hettich	
Zinc CSK Saw Thread Screw	08
Zinc Pan Head Saw Thread Screw	08
Handle Fixing Screw	09
Stainless Steel (SS 410) CSK Saw Thread Screw	09
Euro Countersunk	09
Hardware Fixing Screw & Rear Panel Fixing Screw	10
CSK Nickel, Wooden Dowel & Suspension hook	11
Heco	
Countersunk, Pan Head, Multi Monti Screw	12
Accessories	
Insert Hex socket, T Nut & Connector	13
Drill Bit & Screw Driver	14
Furniture Fittings	
Auto Close and Integrated Soft Close Hinge	16-17
Hepo Telescopic Channel	18
Wire Basket System	19
Bathroom Accessories	21-23
Door Hinges	
Butt Hinges	25-26

## Retail Products

Price List w.e.f. January 2020

Furniture Fittings	
FR - 302 Roller Runner	29
Single Skin Metal Box	30
Shelf Support	31-32
Magnetic Catches & Locks	33-34
Handles for Furniture	35
Bed Fitting Mechanism	37-38
Portable Dish Drainer	39
Dust Bin	40
Door Locks	
Cylindrical Knob & Handle Locks	42-43

*Hardware for Professionals*

**hepo**

A Hettich & Poddar JV

he  
po

*Distribution Products*

## Screws

### Knowledge Centre

Hepo offers wide range of screws in India ideally suitable for all type of wood, plastic, masonry and sheet metal. The Hepo screw family comprises of brands like Heco, Hettich and Hepo.

Hepo provides complete range of woodworking and building and construction screw i.e. Chipboard screw, Drywall screws (black phosphate), Self-drilling screws, Self-tapping screw, Handle fixing screws, Truss head and roofing screws. Hepo screws are made from hardened steel. What differentiates Hepo screws from other available in market are:

**Saw Thread** - Gives better and faster cutting strength for the screw inside the material. Thus, a carpenter has to use less force and effort during drilling.

**Pozi Drive** - It has eight times better grip than a slotted head and two times better than Philips head, allowing greater torque.

**Sharp Tip** - Optimized tip geometry for better positioning and stacking of the screw, even on hard surface

**High Thread Pitch** - Gives faster drive and better contact with the substrate thereby reducing the time of installation.

**Packaging** - Hepo screws are available in different pack sizes i.e. bulk/retail/small pack as per the customer needs.

**Available Screws:**

Zinc Coated, Stainless Steel, Blackodized, Special Screws & Accessories

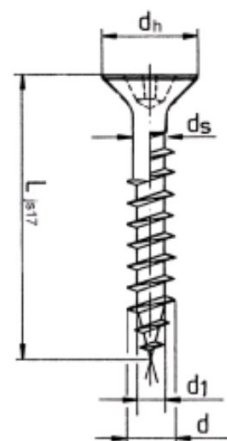
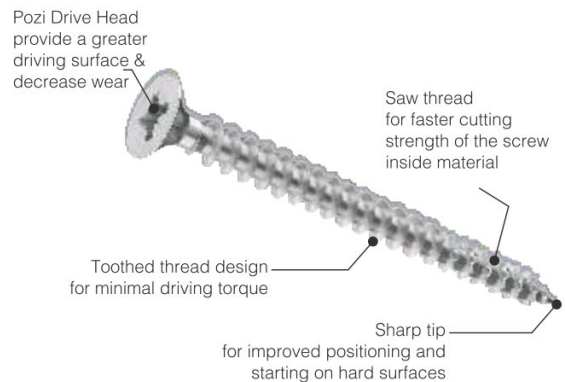

d : Thread diameter  
 d1 : Core diameter  
 ds : Shank diameter  
 L : Screw length  
 dh : Head diameter

**Naming Convention for Chipboard Screws**

Consider 4 x 20

4 is the diameter of the thread in 'mm'(Including the thread)  
20 is the length of the screw in 'mm'

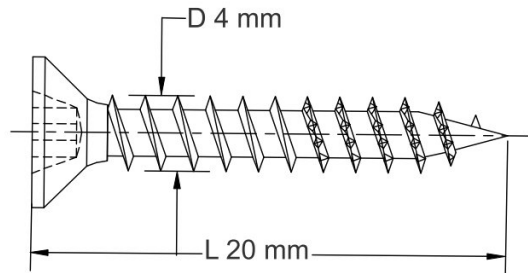

**Naming Convention for Machine Screws**

Consider M4x26

4 is the diameter in 'mm'  
26 is the length of the screw in 'mm'

Specifying the Screw:

Panel thickness + 6 mm to pierce into the handle  
e.g: For a 16 mm Panel, 22 mm screw length can be suggested to fix a handle, knob etc

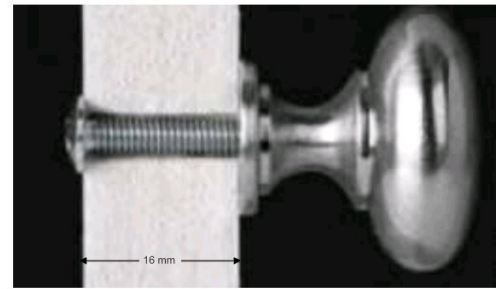

**Screws : Nomenclature**

As per Screw Heads



Slotted Head

Phillips Head

Pozi Drive

As per Screw Head Shape



Countersunk Head

Pan Head

Hexagonal Head

Indian Market follows imperial system (Gauge & Inch) Which allows suppliers to sell shorter screws against any required size

**Conversion Chart- Imperial System to Metric System**

Diameter		Length	
Gauge No.	mm	Inch	mm
2	2	1/4	6
3	2.5	3/8	10
4	3	1/2	12
5	3	5/8	16
6	3.5	3/4	20
7	4	1	25
8	4	1 1/4	30
9	4.5	1 1/2	40
10	5	1 3/4	45
12	5.5	2	50
12	6	2 1/4	55
14	8	2 1/2	60
		2 3/4	70
		3	75
		3 1/2	90
		4	100
		4 1/2	110
		5	130
		6	150

Note: There is tradition of citing screw diameter in gauge & screw length in inches

# Hepo Screws

CSK, Pan head & SS 304 Screws



## Zinc CSK Regular Thread - Retail Packing



Material : Steel  
 Finish : Zinc Coated  
 Head : Countersunk  
 Drive : Pozi Drive  
 Thread : Regular  
 Packing : Retail

S.No.	Dimension	Size	Article No.	Unit	PU	MRP/100
1	Ø3.5 x 12	12/6	5 411 120 40*	Pc	1000	57*
2	Ø3.5 x 16	16/6	5 411 120 50	Pc	1000	64
3	Ø3.5 x 20	20/6	5 411 120 60	Pc	1000	68
4	Ø3.5 x 25	25/6	5 411 120 70	Pc	1000	74
5	Ø3.5 x 30	30/6	5 411 120 80	Pc	1000	87
6	Ø3.5 x 35	35/6	5 411 120 90*	Pc	1000	92*
7	Ø4.0 x 16	16/8	5 411 121 20	Pc	1000	64
8	Ø4.0 x 20	20/8	5 411 121 30	Pc	1000	76
9	Ø4.0 x 25	25/8	5 411 121 40	Pc	1000	85
10	Ø4.0 x 30	30/8	5 411 121 50	Pc	1000	97
11	Ø4.0 x 35	35/8	5 411 121 60	Pc	500	108
12	Ø4.0 x 40	40/8	5 411 121 70	Pc	500	132
13	Ø4.0 x 45	45/8	5 411 121 80*	Pc	500	142*
14	Ø4.0 x 50	50/8	5 411 121 90	Pc	500	158
15	Ø5.0 x 50	50/10	5 411 122 30	Pc	200	224
16	Ø5.0 x 60	60/10	5 411 122 40	Pc	200	315
17	Ø5.0 x 70	70/10	5 411 122 50	Pc	200	365

## Zinc Pan head Regular Thread-Retail Packing



Material : Steel  
 Finish : Zinc Coated  
 Head : Pan Head  
 Drive : Pozi Drive  
 Thread : Regular  
 Packing : Retail

S.No.	Dimension	Size	Article No.	Unit	PU	MRP/100
1	Ø3.5 x 16	16/6	5 411 220 50*	Pc	1000	75*
2	Ø4.0 x 16	16/8	5 411 221 20	Pc	1000	82
3	Ø4.0 x 25	25/8	5 411 221 40	Pc	1000	101
4	Ø4.0 x 30	30/8	5 411 221 50	Pc	500	129

## Zinc Pan head Regular Thread\*-Industrial Packing



Material : Steel hardened  
 Finish : Zinc  
 Head : Pan Head  
 Drive : Pozi Drive  
 Thread : Regular  
 Packing : Industrial

S.No.	Dimension	Size	Article No.	Unit	PU	MRP/100
1	Ø3.5 x 12	12/6	9 193 091 00*	Pc	22000	46
2	Ø3.5 x 16	16/6	9 193 092 00*	Pc	20000	52
3	Ø4.0 x 16	16/8	9 193 093 00*	Pc	15000	62
4	Ø4.0 x 20	20/8	9 216 225 00*	Pc	12000	72
5	Ø4.0 x 25	25/8	9 193 094 00*	Pc	10000	81
6	Ø4.0 x 30	30/8	9 194 178 00*	Pc	9000	97

## Zinc CSK Regular Thread-Industrial Packing



Material : Steel hardened  
 Finish : Zinc  
 Head : Countersunk  
 Drive : Pozi Drive  
 Thread : Regular  
 Packing : Industrial

S.No.	Dimension	Size	Article No.	Unit	PU	MRP/100
1	Ø3.0 x 12	12/5	9 193 028 00*	Pc	43000	40*
2	Ø3.5 x 12	12/6	9 193 029 00*	Pc	31000	41*
3	Ø3.5 x 16	16/6	9 193 030 00	Pc	25000	41
4	Ø3.5 x 20	20/6	9 193 071 00	Pc	22000	45
5	Ø3.5 x 25	25/6	9 193 072 00	Pc	17000	51
6	Ø3.5 x 30	30/6	9 193 073 00	Pc	14500	59
7	Ø4.0 x 16	16/8	9 193 074 00	Pc	19000	49
8	Ø4.0 x 20	20/8	9 193 075 00	Pc	16000	52
9	Ø4.0 x 25	25/8	9 193 076 00	Pc	13000	60
10	Ø4.0 x 30	30/8	9 193 077 00	Pc	11000	69
11	Ø4.0 x 35	35/8	9 193 078 00	Pc	10000	77
12	Ø4.0 x 40	40/8	9 193 079 00	Pc	8000	86
13	Ø4.0 x 50	40/8	9 193 080 00	Pc	6000	102

## Stainless Steel CSK Regular Thread - Retail Packing



Material : SS-304  
 Finish : Stainless Steel  
 Head : Countersunk  
 Drive : Phillips Drive  
 Thread : Regular  
 Packing : Retail

S.No.	Dimension	Size	Article No.	Unit	PU	MRP/100
1	Ø3.5 x 16	16/6	9 265 099 00	Pc	1000	111
2	Ø3.5 x 20	20/6	9 265 100 00	Pc	1000	125
3	Ø3.5 x 25	25/6	9 265 131 00	Pc	1000	160
4	Ø3.5 x 35	35/6	9 265 132 00	Pc	1000	225
5	Ø4.0 x 16	16/8	9 265 133 00	Pc	1000	150
6	Ø4.0 x 20	20/8	9 265 134 00	Pc	1000	165
7	Ø4.0 x 30	30/8	9 265 135 00	Pc	1000	240
8	Ø4.0 x 35	35/8	9 265 136 00	Pc	500	270
9	Ø4.0 x 40	40/8	9 265 137 00	Pc	500	310
10	Ø5.0 x 60	60/10	9 265 138 00	Pc	250	725
11	Ø5.0 x 70	70/10	9 265 139 00	Pc	250	760

\*Subject to stock availability / on request basis

# Hepo Screws

Self Drilling Screw With Rib, Self Tapping Screws,  
Hexagonal Head Self Drilling Screws With Washer & Drywall Screws



## Self Drilling Screw With Rib - Retail Packing



Material : Steel  
Finish : Zinc  
Head : Countersunk  
Drive : Phillips Drive  
Thread : Self Drilling  
Packing : Retail

S.No.	Dimension	Size	Article No.	Unit	PU	MRP/100
1	M3.5 x 13	13/6	9 261 082 00	Pc	1000	66
2	M3.5 x 16	16/6	9 261 083 00	Pc	1000	72
3	M3.5 x 19	19/6	9 261 084 00	Pc	1000	78
4	M3.5 x 25	25/6	9 261 086 00	Pc	1000	88
5	M3.5 x 32	32/6	9 261 087 00	Pc	1000	112
6	M4.2 x 13	13/8	9 261 091 00	Pc	1000	81
7	M4.2 x 16	16/8	9 261 092 00	Pc	1000	89
8	M4.2 x 19	19/8	9 261 093 00	Pc	1000	95
9	M4.2 x 25	25/8	9 261 094 00	Pc	1000	110
10	M4.2 x 32	32/8	9 261 095 00	Pc	500	134
11	M4.2 x 40	40/8	9 261 097 00	Pc	500	172
12	M4.2 x 50	50/8	9 261 208 00	Pc	500	200
13	M4.8 x 50	50/10	9 261 212 00	Pc	300	296
14	M4.8 x 70	70/10	9 261 214 00	Pc	350	396
15	M4.8 x100	100/10	9 261 215 00	Pc	200	554

## Hexagonal Head Self Drilling Screw With Washer



Material : Steel  
Finish : Zinc  
Head : Hexagonal  
Drive : Phillips Drive  
Thread : Self Drilling  
Packing : Retail

S.No.	Dimension	Size	Article No.	Unit	PU	MRP/100
1	Ø4.2 X 16	16/8	9 278 168 00	Pc	200	138
2	Ø4.2 X 19	19/8	9 278 169 00	Pc	200	140
3	Ø4.2 X 25	25/8	9 278 170 00	Pc	200	156
4	Ø4.8 X 19	19/10	9 278 171 00	Pc	200	190
5	Ø4.8 X 25	25/10	9 278 172 00	Pc	200	208
6	Ø4.8 X 32	32/10	9 278 173 00	Pc	200	238
7	Ø4.8 X 38	38/10	9 278 174 00	Pc	200	250
8	Ø4.8 X 55	55/10	9 278 177 00	Pc	200	325
9	Ø4.8 X 75	75/10	9 278 179 00	Pc	100	380
10	Ø5.5 X 25	25/12	9 278 181 00	Pc	200	250
11	Ø5.5 X 32	32/12	9 278 182 00	Pc	200	280
12	Ø5.5 X 40	40/12	9 278 185 00	Pc	200	320
13	Ø5.5 X 45	45/12	9 278 186 00	Pc	200	340
14	Ø5.5 X 76	76/12	9 278 191 00	Pc	100	505

## Self Tapping Screw Countersunk\*- Retail Packing



Material : Steel  
Finish : Zinc  
Head : Countersunk  
Drive : Pozi Drive  
Thread : Self Tapping  
Packing : Retail

S.No.	Dimension	Size	Article No.	Unit	PU	MRP/100
1	Ø3.5 x 13	13/6	5 111 133 30	Pc	1000	52
2	Ø3.5 x 16	16/6	5 111 133 00	Pc	1000	59
3	Ø3.5 x 20	20/6	5 111 138 20	Pc	1000	67
4	Ø3.5 x 25	25/6	5 111 138 30	Pc	1000	80
5	Ø3.5 x 35	35/6	5 111 138 50	Pc	1000	101
6	Ø3.5 x 50	50/6	5 111 139 50	Pc	500	138

## Drywall Screw - Retail Packing



Material : Steel  
Finish : Black  
Drive : Phillips Drive  
Thread : Fine Thread  
Packing : Retail

S.No.	Dimension	Size	Article No.	Unit	PU	MRP/100
1	M3.5x20	20/6	9 262 479 00	Pc	1000	51
2	M3.5x25	25/6	9 262 480 00	Pc	1000	59
3	M3.5x30	30/6	9 262 511 00	Pc	1000	71
4	M3.5x35	35/6	9 262 512 00	Pc	1000	79
5	M3.5x40	40/6	9 262 513 00	Pc	500	85
6	M3.5x45	45/6	9 262 514 00	Pc	500	96
7	M3.5x50	50/6	9 262 515 00	Pc	500	105

## Self Tapping Screw Pan Head\*- Retail Packing



Material : Steel  
Finish : Zinc  
Head : Pan head  
Drive : Pozi Drive  
Thread : Self Tapping  
Packing : Retail

S.No.	Dimension	Size	Article No.	Unit	PU	MRP/100
1	Ø3.5 x 25	25/6	5 111 230 70	Pc	1000	92
2	Ø4.2 x 19	19/8	5 111 234 30	Pc	1000	108

\*Subject to stock availability / on request basis



# Hepo Screws

## Blackodised Chipboard Screws



### Blackodised Countersunk - Retail Packing



Material : Steel  
 Finish : Blackodised  
 Head : Countersunk  
 Drive : Pozi Drive  
 Thread : Regular  
 Packing : Retail

S.No.	Dimension	Size	Article No.	Unit	PU	MRP/100
1	Ø3 X16	16/5	5 412 120 30*	Pc	1000	48*
2	Ø3.5 x 12	12/6	5 412 120 40*	Pc	1000	49*
3	Ø3.5 x 16	16/6	5 412 120 50	Pc	1000	60
4	Ø3.5 x 20	20/6	5 412 120 60	Pc	1000	63
5	Ø3.5 x 25	25/6	5 412 120 70	Pc	1000	66
6	Ø3.5 x 30	30/6	5 412 120 80	Pc	1000	74
7	Ø3.5 x 35	35/6	5 412 120 90	Pc	1000	82
8	Ø4.0 x 16	16/8	5 412 121 20	Pc	1000	66
9	Ø4.0 x 20	20/8	5 412 121 30	Pc	1000	74
10	Ø4.0 x 25	25/8	5 412 121 40	Pc	1000	82
11	Ø4.0 x 30	30/8	5 412 121 50	Pc	1000	96
12	Ø4.0 x 35	35/8	5 412 121 60	Pc	500	109
13	Ø4.0 x 40	40/8	5 412 121 70	Pc	500	121
14	Ø4.0 x 45	45/8	5 412 121 80*	Pc	500	131*
15	Ø4.0 x 50	50/8	5 412 121 90	Pc	500	146
16	Ø5.0 x 50	50/10	5 412 122 30	Pc	200	231
17	Ø5.0 x 60	60/10	5 412 122 40	Pc	200	268
18	Ø5.0 x 70	70/10	5 412 122 50	Pc	200	313

### Blackodised Pan Head - Retail Packing



Material : Steel  
 Finish : Blackodised  
 Head : Pan Head  
 Drive : Pozi Drive  
 Thread : Regular  
 Packing : Retail

S.No.	Dimension	Size	Article No.	Unit	PU	MRP/100
1	Ø3.5 x 12	12/6	5 412 220 40	Pc	1000	62
2	Ø3.5 x 16	16/6	5 412 220 50	Pc	1000	77
3	Ø4 x 16	16/8	5 412 221 20	Pc	1000	94
4	Ø4 x 20	20/8	5 412 221 30	Pc	1000	102
5	Ø4 x 25	25/8	5 412 221 40	Pc	1000	113
6	Ø4 x 30	30/8	5 412 221 50	Pc	500	127

### Blackodised Countersunk - Industrial Packing



Material : Steel  
 Finish : Blackodised  
 Head : Countersunk  
 Drive : Pozi Drive  
 Thread : Regular  
 Packing : Industrial

S.No.	Dimension	Size	Article No.	Unit	PU	MRP/100
1	Ø3.5 x 12	12/6	9 215 108 00	Pc	31000	34
2	Ø3.5 x 16	16/6	9 215 109 00	Pc	25000	38
3	Ø3.5 x 20	20/6	9 215 110 00	Pc	22000	42
4	Ø3.5 x 25	25/6	9 215 111 00	Pc	17000	51
5	Ø3.5 x 30	30/6	9 215 112 00*	Pc	14500	58*
6	Ø4.0 x 16	16/8	9 236 639 00	Pc	19000	54
7	Ø4.0 x 20	20/8	9 236 641 00*	Pc	16000	62*
8	Ø4.0 x 25	25/8	9 236 642 00*	Pc	13000	69*
9	Ø4.0 x 30	30/8	9 236 643 00*	Pc	11000	85*
10	Ø4.0 x 35	35/8	9 236 644 00	Pc	10000	97
11	Ø4.0 x 40	40/8	9 215 113 00	Pc	8000	86
12	Ø5.0 x 50	50/10	9 215 114 00*	Pc	4500	157*

### Blackodised Pan Head\*- Industrial Packing



Material : Steel  
 Finish : Blackodised  
 Head : Pan Head  
 Drive : Pozi Drive  
 Thread : Regular  
 Packing : Industrial

S.No.	Dimension	Size	Article No.	Unit	PU	MRP/100
1	Ø3.5 x 12	12/6	9 215 115 00	Pc	22000	43
2	Ø3.5 x 16	16/6	9 215 116 00	Pc	20000	45
3	Ø3.5 x 25	25/6	9 215 127 00	Pc	15000	56
4	Ø4 x 16	16/8	9 236 646 00	Pc	15000	73
5	Ø4 x 20	20/8	9 236 647 00	Pc	12000	82
6	Ø4 x 25	25/8	9 236 648 00	Pc	10000	91
7	Ø4 x 30	30/8	9 236 649 00	Pc	9000	105
8	Ø4 x 35	35/8	9 236 650 00	Pc	8000	114
9	Ø4 x 40	40/8	9 236 651 00	Pc	7000	126
10	Ø4 x 50	50/8	9 236 652 00	Pc	5500	149

\*Subject to stock availability / on request basis

# Hettich Screws

## Zinc Coated Steel CSK & Pan Head Saw Thread Screws



### Zinc CSK Saw Thread - Retail Packing



Material : Steel  
 Finish : Zinc Coated  
 Head : Countersunk  
 Drive : Pozi Drive  
 Thread : Saw  
 Packing : Retail

S.No.	Dimension	Size	Article No.	Unit	PU	MRP
1	Ø3 x 10	10/5	9 169 369 00*	Pc	1000	62*
2	Ø3 x 12	12/5	9 162 378 00	Pc	1000	63
3	Ø3 x 16	16/5	9 169 370 00	Pc	1000	64
4	Ø3.5 x 12	12/6	9 148 092 00	Pc	1000	64
5	Ø3.5 x 16	16/6	9 137 980 00	Pc	1000	68
6	Ø3.5 x 20	20/6	9 153 820 00	Pc	1000	73
7	Ø3.5 x 25	25/6	9 162 379 00	Pc	1000	81
8	Ø3.5 x 30	30/6	9 162 380 00	Pc	1000	95
9	Ø3.5 x 35	35/6	9 169 371 00	Pc	1000	103
10	Ø3.5 x 40	40/6	9 162 381 00	Pc	500	116
11	Ø4.0 x 12	12/8	9 169 372 00	Pc	1000	73
12	Ø4.0 x 16	16/8	9 137 992 00	Pc	1000	82
13	Ø4.0 x 20	20/8	9 137 991 00	Pc	1000	86
14	Ø4.0 x 25	25/8	9 137 993 00	Pc	1000	97
15	Ø4.0 x 30	30/8	9 140 272 00	Pc	1000	112
16	Ø4.0 x 35	35/8	9 140 274 00	Pc	500	130
17	Ø4.0 x 40	40/8	9 140 275 00	Pc	500	141
18	Ø4.0 x 45	45/8	9 140 276 00	Pc	500	153
19	Ø4.0 x 50	50/8	9 169 373 00	Pc	500	165
20	Ø4.5 x 16	16/9	9 140 277 00*	Pc	1000	97*
21	Ø4.5 x 20	20/9	9 169 374 00*	Pc	1000	105*
22	Ø4.5 x 25	25/9	9 137 994 00*	Pc	500	130*
23	Ø4.5 x 30	30/9	9 137 995 00*	Pc	500	147*
24	Ø4.5 x 35	35/9	9 137 996 00*	Pc	500	167*
25	Ø4.5 x 40	40/9	9 137 997 00*	Pc	500	178*
26	Ø4.5 x 50	50/9	9 137 998 00	Pc	200	236
27	Ø5.0 x 50	50/10	9 148 093 00	Pc	200	297
28	Ø5.0 x 60	60/10	9 153 821 00	Pc	200	341
29	Ø5.0 x 70	70/10	9 153 822 00	Pc	200	407
30	Ø5.0 x 80	80/10	9 169 376 00	Pc	100	489
31	Ø5.0 x 90	90/10	9 169 378 00	Pc	100	588
32	Ø5.0 x 100	100/10	9 169 380 00	Pc	100	685

### Zinc CSK Saw Thread - Industrial Packing



Material : Steel  
 Finish : Zinc  
 Head : Countersunk  
 Drive : Pozi Drive  
 Thread : Saw  
 Packing : Industrial

S.No.	Dimension	Size	Article No.	Unit	PU	MRP
1	Ø3.5 x 12	12/6	9 200 221 00	Pc	28000	51
2	Ø3.5 x 16	16/6	9 200 222 00	Pc	25000	51
3	Ø3.5 x 20	20/6	9 200 223 00	Pc	20000	56
4	Ø4.0 x 16	16/8	9 200 224 00	Pc	17000	61
5	Ø4.0 x 20	20/8	9 200 225 00	Pc	15000	65
6	Ø4.0 x 25	25/8	9 200 226 00	Pc	13000	75
7	Ø4.0 x 30	30/8	9 200 227 00	Pc	10000	86
8	Ø4.0 x 35	35/8	9 200 228 00	Pc	9000	96
9	Ø4.0 x 40	40/8	9 200 229 00*	Pc	8000	108*
10	Ø4.0 x 45	45/8	9 200 250 00*	Pc	7500	120*
11	Ø4.5 x 45	45/9	9 200 251 00*	Pc	6000	142*
12	Ø5.0 x 50	50/10	9 200 252 00	Pc	4500	194
13	Ø5.0 x 60	60/10	9 200 253 00	Pc	3200	221*
14	Ø5.0 x 70	70/10	9 200 254 00	Pc	2300	259*

### Zinc Pan head Saw Thread - Retail Packing



Material : Steel  
 Finish : Zinc Coated  
 Head : Pan Head  
 Drive : Pozi Drive  
 Thread : Saw  
 Packing : Retail

S.No.	Dimension	Size	Article No.	Unit	PU	MRP
1	Ø3.0 x 12	12/5	9 169 381 00	Pc	1000	72
2	Ø3.0 x 16	16/5	9 169 382 00	Pc	1000	75
3	Ø3.5 x 12	12/6	9 169 383 00	Pc	1000	72
4	Ø3.5 x 16	16/6	9 169 384 00	Pc	1000	75
5	Ø3.5 x 20	20/6	9 169 385 00	Pc	1000	83
6	Ø4.0 x 16	16/8	9 137 999 00	Pc	1000	82
7	Ø4.0 x 25	25/8	9 140 282 00	Pc	1000	101
8	Ø4.0 x 30	30/8	9 169 386 00	Pc	500	130
9	Ø4.0 x 35	35/8	9 169 387 00	Pc	500	147
10	Ø4.0 x 40	40/8	9 169 388 00	Pc	500	162
11	Ø4.0 x 45	45/8	9 169 389 00	Pc	200	178
12	Ø4.0 x 50	50/8	9 169 390 00	Pc	200	196
13	Ø4.5 x 16	16/9	9 138 000 00	Pc	500	108
14	Ø4.5 x 20	20/9	9 138 021 00	Pc	500	118
15	Ø5.0 x 50	50/10	9 169 391 00	Pc	200	296
16	Ø6.0 x 35	35/12	9 169 392 00	Pc	200	339
17	Ø6.0 x 50	50/12	9 169 393 00	Pc	200	437

\*Subject to stock availability / on request basis

# Hettich Screws

Handle Fixing Screws, SS CSK Saw Thread Screws  
SS 410 Screws & Euro Countersunk Head



## Handle Fixing Screw - Retail Packing



Material : Steel  
Finish : Zinc Coated  
Head : Pan Head  
Drive : Cross recessed  
Thread : M4  
Packing : Retail

S.No.	Dimension	Article No.	Unit	PU	MRP/100
1	M4 x 20	7 154 8	Pc	1000	139
2	M4 x 22	7 154 9	Pc	1000	143
3	M4 x 24	7 155 5	Pc	1000	143
4	M4 x 26	7 155 6	Pc	1000	154
5	M4 x 28	7 155 7	Pc	500	165
6	M4 x 30	7 155 8	Pc	500	165
7	M4 x 32	7 155 9	Pc	500	176
8	M4 x 34	7 156 0	Pc	500	187
9	M4 x 36	7 156 1	Pc	500	198
10	M4 x 38	7 156 2	Pc	500	209
11	M4 x 40	7 156 3*	Pc	200	220*
12	M4 x 50	9 184 222	Pc	200	252

## Hettich SS 410 Small Pack\*



Material : SS 410  
Finish : Stainless Steel  
Head : Countersunk  
Drive : Pozi Drive  
Thread : Saw  
Packing : Retail

S.No.	Dimension	Size	Article No.	Unit	PU	MRP/100
1	Ø3.5 x 12	12/6	9 277 113 00	Pc	200	107
2	Ø3.5 x 16	16/6	9 277 114 00	Pc	200	121
3	Ø3.5 x 20	20/6	9 277 115 00	Pc	200	139
4	Ø3.5 x 25	25/6	9 277 117 00	Pc	200	169
5	Ø3.5 x 30	30/6	9 277 118 00	Pc	200	183
6	Ø3.5 x 35	35/6	9 277 119 00	Pc	200	214
7	Ø4.0 x 16	16/8	9 277 120 00	Pc	150	154
8	Ø4.0 x 20	20/8	9 277 131 00	Pc	200	176
9	Ø4.0 x 25	25/8	9 277 132 00	Pc	200	209
10	Ø4.0 x 30	30/8	9 277 133 00	Pc	200	242
11	Ø4.0 x 35	35/8	9 277 134 00	Pc	150	264
12	Ø4.0 x 40	40/8	9 277 135 00	Pc	150	315
13	Ø5.0 x 50	50/10	9 277 143 00	Pc	100	592
14	Ø5.0 x 60	60/10	9 277 144 00	Pc	80	726
15	Ø5.0 x 70	70/10	9 277 145 00	Pc	80	760

## Stainless Steel CSK Saw Thread-Retail Packing



Material : SS 410  
Finish : Stainless Steel  
Head : Countersunk  
Drive : Pozi Drive  
Thread : Saw  
Packing : Retail

S.No.	Dimension	Size	Article No.	Unit	PU	MRP/100
1	Ø3.5 x 12	12/6	9 162 382 00	Pc	1000	107
2	Ø3.5 x 16	16/6	9 154 452 00	Pc	1000	121
3	Ø3.5 x 20	20/6	9 162 383 00	Pc	1000	139
4	Ø3.5 x 25	25/6	9 162 384 00	Pc	1000	169
5	Ø3.5 x 30	30/6	9 162 385 00	Pc	1000	183
6	Ø3.5 x 35	35/6	9 162 386 00	Pc	1000	214
7	Ø4.0 x 16	16/8	9 162 388 00	Pc	1000	154
8	Ø4.0 x 20	20/8	9 154 453 00	Pc	1000	176
9	Ø4.0 x 25	25/8	9 154 454 00	Pc	1000	209
10	Ø4.0 x 30	30/8	9 154 455 00	Pc	1000	242
11	Ø4.0 x 35	35/8	9 154 456 00	Pc	500	264
12	Ø4.0 x 40	40/8	9 162 389 00	Pc	500	315
13	Ø4.5 x 45	45/9	9 154 458 00	Pc	500	429*
14	Ø5.0 x 50	50/10	9 154 459 00	Pc	200	592
15	Ø5.0 x 60	60/10	9 169 394 00	Pc	200	726
16	Ø5.0 x 70	70/10	9 154 461 01	Pc	200	760

## Euro Countersunk Head\*- Retail Packing







Material : Steel  
Finish : Zinc Coated  
Head : Shallow Countersunk  
Drive : Pozi Drive  
Packing : Retail

S.No.	Description	Dimension	Article No.	Unit	PU	MRP/100
1	Shallow CSK Head	Ø4.5 x 13.5	7 375 1	Pc	200	445
2	Shallow CSK Head	Ø6.3 x 10.5	5 126 4	Pc	200	277
3	Shallow CSK Head	Ø6.3 x 11	4 745 1	Pc	200	160
4	Shallow CSK Head	Ø6.3 x 12.5	7 375 2	Pc	200	168
5	Shallow CSK Head	Ø6.3 x 14	5 126 5	Pc	200	182
6	Shallow CSK Head	Ø6.3 x 15	7 388 9	Pc	200	652
7	Shallow CSK Head	Ø6.3 x 18	5 279 9	Pc	200	674
8	Deep CSK Head	Ø6.3 x 10.5	7 389 0	Pc	200	606
9	Deep CSK Head	Ø6.3 x 14	4 745 2	Pc	200	215

\*Subject to stock availability / on request basis

### Hettich Hardware Fixing Screws\* -Retail Packing

Material : Steel  
 Finish : Zinc Coated / Nickel Plated  
 Head : Countersunk / Pan head  
 Drive : Pozi Drive  
 Packing : Retail

S.No.	Description	Image	Dimension	Article No.	Unit	PU	MRP/100
1	Screw Countersunk and sleeve for socket adoption.		Ø 10 x 11	4 516 9	Set	1000	683
2	Chipboard Screw Countersunk Head		Ø 3.5 x 16	7 192 5	Nos	200	174
3	Fixing Screw for Alu profile frame door hinges		Ø 3.5 x 9.5	4 129 6	Nos	200	178
4	Fixing Screw for glass door hinges		Ø 4.0 x 16	9 082 429	Nos	200	560
5	Fixing screw, Countersunk head steel nickel plate		Ø 4.0 x 12	1 008 5	Nos	200	234

### Rear Panel Fixing Screw - Retail Packing

Material : Steel  
 Finish : Zinc Coated / Nickel Plated  
 Head : Countersunk / Pan head  
 Drive : Pozi Drive  
 Packing : Retail

S.No.	Description	Image	Dimension	Article No.	Unit	PU	MRP/100
1	Direct fixing screw Pan head, Nickel		Ø6.3 x 13	4 000 7	Pc	200	282
2	Chipboard screw CSK galvanised		Ø3.5 x 12	5 824 4	Pc	200	157
3	Direct fixing screw Pan head		Ø4.0 x 12	5 824 3	Pc	200	348
4	Direct fixing screw Oval head, polished		M6 x 12	5 824 2	Pc	200	945

\*Subject to stock availability / on request basis

### Countersunk Nickel - Retail Packing

Material : Steel  
 Finish : Galvanised / Nickel  
 Head : Countersunk  
 Packing : Retail

S.No.	Description	Image	Dimension	Article No.	Unit	PU	MRP/100
1	Countersunk, Nickel		Ø3.5 x 13	0 048 296	Pc	200	155
2	Countersunk, Nickel		Ø3.5 x 16	7 192 5	Pc	200	174
3	Countersunk, Nickel		Ø3.5 x 9.5	4 129 6	Pc	200	178
4	Countersunk, Nickel		Ø4.0 x 16	1 008 5	Pc	200	234

### Wooden Dowel & Suspension Hook - Retail Packing

Material : Plastic / Steel / Wood  
 Finish : White  
 Packing : Retail

S.No.	Description	Image	Dimension	Article No.	Unit	PU	MRP/100
1	Wooden Dowel		Ø 8.0 x 40	6 924 1	Pc	2000	92
2	Suspension hook Wall Plug		Ø 6.0 x 50 Ø 8.0 x 40	4 610 3	Pc	100	1569
3	Special screw Wall plug		Ø 5.5 x 50 Ø 8.0 x 40	6 548 0	Pc	100	1846

# HECO Screws

HECO FIX-plus® Countersunk,  
HECO FIX-plus® Pan Head & Multi Monti Screws



## Zinc Countersunk Full Thread - Retail Packing



Material : Steel hardened  
Finish : Bright zinc plated  
Head : Countersunk  
Drive : Pozi Drive  
Packing : Retail

S.No.	Dimension	Gauge	Article No.	Unit	PU	MRP/100
1	Ø3.0 x 10	5	1 180 176 91*	Pc	1000	156*
2	Ø3.0 x 12	5	9 163 00 400*	Pc	1000	156*
3	Ø3.5 x 16	6	1 180 023 00	Pc	1000	154
4	Ø3.5 x 20	6	9 163 005 00	Pc	1000	168
5	Ø3.5 x 25	6	1 180 021 00*	Pc	1000	178*
6	Ø3.5 x 30	6	1 180 022 00*	Pc	1000	193*
7	Ø4.0 x 12	8	1 180 125 00*	Pc	1000	181*
8	Ø4.0 x 16	8	1 180 151 00	Pc	1000	181
9	Ø4.0 x 20	8	1 180 168 00	Pc	1000	198
10	Ø4.0 x 25	8	1 180 169 00	Pc	1000	220
11	Ø4.0 x 30	8	1 180 017 00	Pc	1000	242
12	Ø4.0 x 35	8	1 180 171 00	Pc	500	286
13	Ø4.0 x 40	8	1 180 026 00*	Pc	500	308*
14	Ø4.0 x 45	8	1 180 019 00*	Pc	500	352*
15	Ø4.0 x 50	8	1 180 018 00	Pc	500	399
16	Ø4.5 x 20	9	1 180 028 00*	Pc	1000	265*
17	Ø4.5 x 25	9	1 180 446 47*	Pc	500	299*
18	Ø4.5 x 30	9	1 180 159 51*	Pc	500	318*
19	Ø4.5 x 40	9	1 180 162 14*	Pc	500	374*
20	Ø4.5 x 45	9	1 180 167 95*	Pc	500	495*
21	Ø4.5 x 50	9	1 180 152 99*	Pc	200	508*
22	Ø4.5 X 55	9	1 180 160 87*	Pc	200	768*
23	Ø4.5 x 60	9	1 180 160 87*	Pc	200	654*
24	Ø4.5 x 70	9	1 180 169 58*	Pc	200	894*
25	Ø5.0 x 50	10	9 222 042 00	Pc	200	593
26	Ø5.0 x 70	10	1 180 016 00	Pc	200	934
27	Ø5.0 x 90	10	9 155 414 00	Pc	200	1349
28	Ø6.0 x 40	12	1 180 020 00	Pc	200	886*

## Zinc Pan Head Full Thread\* - Retail Packing



Material : Steel hardened  
Finish : Bright zinc plated  
Head : Panhead  
Drive : Pozi Drive  
Thread : Saw  
Packing : Retail

S.No.	Dimension	Gauge	Article No.	Unit	PU	MRP/100
1	Ø3.5 x 12	6	1 180 12600	Pc	1000	187
2	Ø4.0 x 12	8	1 180 068 38	Pc	1000	212
3	Ø4.0 x 15	8	1 180 114 00	Pc	1000	212
4	Ø4.0 x 16	8	1 180 115 00	Pc	1000	198
5	Ø4.0 x 20	8	1 180 117 00	Pc	1000	220
6	Ø4.0 x 25	8	1 180 072 70	Pc	1000	242
7	Ø4.0 x 30	8	1 180 148 00	Pc	1000	268
8	Ø4.5 x 16	9	1 180 445 97	Pc	500	280
9	Ø4.5 x 20	9	1 180 446 02	Pc	500	308
10	Ø4.5 x 25	9	1 180 446 06	Pc	500	336
11	Ø4.5 x 40	9	9 145 700 00	Pc	500	418
12	Ø4.5 x 45	9	9 145 731 00	Pc	500	549
13	Ø5.0 x 70	10	9 259 692 00	Pc	200	1100

## Multi - Monti+ SS Hexagon Head Screws\*



Material : Steel hardened  
Finish : Bright Zinc Plated  
Head : Hexagonal  
Drive : T-Drive  
Packing : Retail

S.No.	Dimension	Article No.	Unit	PU	MRP/100
1	7.5 x 80	9 252 629 00	Pc	50	61
2	7.5 x 100	9 252 630 00	Pc	50	66
3	7.5 x 120	9 252 631 00	Pc	50	70
4	7.5 x 140	9 252 632 00	Pc	50	87

## Multi - Monti - Plus F Countersunk Head Screws\*



Material : Steel hardened  
Finish : Bright Zinc Plated  
Head : Countersunk  
Drive : T-Drive  
Packing : Retail

S.No.	Dimension	Article No.	Unit	PU	MRP/100
1	7.5 x 80	9 244 974 00	Pc	50	49
2	7.5 x 100	9 244 975 00	Pc	50	54
3	7.5 x 120	9 244 976 00	Pc	50	68
4	7.5 x 140	9 244 977 00	Pc	50	85
5	7.5 x 160	9 245 018 00	Pc	50	91

\*Subject to stock availability / on request basis

# Accessories

Insert Hex Socket, T Nut & Connector



## Insert Hex Socket \*



Material : Steel  
 Finish : Zinc  
 Drive : Hex Socket  
 Thread : Regular / Metric  
 Packing : Bulk

S.No.	Description	Dimension	Article No.	Unit	PU	MRP/100
1	Insert Hex	M 6 X 9	5 211 634 61	Pc	11000	561
2	Insert Hex	M 6 X 12	5 211 634 71	Pc	9000	584
3	Insert Hex	M 6 X 15	5 211 634 91	Pc	6600	821
4	Insert Hex	M 6 X 20	5 211 635 11	Pc	5000	991
5	Insert Hex	M6 X 25	5 211 635 21	Pc	3000	1,575
6	Insert Hex	M8 X 15	5 211 636 71	Pc	5000	1,056
7	Insert Hex	M8 X 20	5 211 636 81	Pc	3000	1,664
8	Insert Hex	M8 X 25	5 211 636 91	Pc	2800	1,801

## T Nut\*



Material : Steel  
 Finish : Zinc  
 Drive : Metric  
 Packing : Retail

S.No.	Description	Dimension	Article No.	Unit	PU	MRP/100
1	T Nut Ø19	M 6 x 9	5 211 034 60	Pc	5500	294
2	T Nut Ø 22	M8 x 12	5 211 036 60	Pc	3500	419

## Connectors

Material : Steel / Plastic  
 Finish : Galvanised / White- Brown  
 Head : Plastic  
 Drive : Slot / Pozidrive  
 Thread : M4 / M6  
 Packing : Retail

S.No.	Description	Image	Dimension	Article No.	Unit	PU	MRP/100
1	VS 29 brown Ø 8 M6		29 - 36	1 310 9	Nos	100	1220
2	VS 34 white Ø 8 M6		34 - 41	1 311 0	Nos	100	1286
3	VS 34 brown Ø 8 M6		34 - 41	1 311 1	Nos	100	1200
4	VS 39 brown Ø 8 M6		39 - 46	1 311 3	Nos	100	1378
5	VS 39 white Ø 8 M6		39 - 46	1 311 2	Nos	100	1671
6	VS 44 white Ø 8 M6		44 - 51	1 311 4	Nos	100	2200
7	VS 44 brown Ø 8 M6		44 - 51	1 311 5	Nos	100	1371
8	Connecting screw VHS 32 M4, panel thickness 28-36		Ø 5 mm	7 965 9	Nos	1000	554
9	Connecting screw VHS 32 M4, panel thickness 36-44		Ø 5 mm	7 966 0	Nos	1000	739
10	End screw		M4 x 8	7 952 5	Nos	200	192
11	Thread sleeve, Ø 5		M4 x 15	6 301 6	Nos	200	563
12	Thread sleeve, Ø 5		M4 x 18	6 490 8	Nos	200	929
13	Thread sleeve, Ø 5		M4 x 22	6 301 7	Nos	200	852
14	Direkta, 2 saw thread		Ø6.3 x 40	1 955 5	Nos	500	542
15	Direkta, 2saw thread		Ø6.3 x 50	1 955 6	Nos	500	395

\*Subject to stock availability/ on request basis

# Accessories

## Drive Bit & Screw Driver



### Screw - Drive - Bit Pozi Drive



Material : Steel hardened  
 Finish : Black  
 Drive : Pozi Drive

S.No.	Description	Suitable for	Article No.	Unit	PU	MRP/Pc
1	Pozi Drive Size 1	≤ 3 mm dia	9 153 723 00	Pc	10	170
2	Pozi Drive Size 2	3.5 - 5 mm dia	9 153 726 00	Pc	10	170
3	Pozi Drive Size 3	≥ 5 mm dia	9 153 727 00	Pc	10	170

### Drive Bit - 65 mm (Both Side) Pozi Drive



Material : Steel hardened  
 Finish : Black  
 Drive : Pozi Drive

S.No.	Description	Suitable for	Article No.	Unit	PU	MRP/Pc
1	PZD -1 Screwdrive bits H1/4*65mm PZ1	≤ 3 mm dia	9 254 671 00	Pc	10	80
2	PZD -2 Screwdrive bits H1/4*65mm PZ2	3.5 - 5 mm dia	9 254 672 00	Pc	10	80
3	PZD -3 Screwdrive bits H1/4*65mm PZ3	≥ 5 mm dia	9 254 673 00	Pc	10	80

### Drive Bit - 65mm (Both Side) Phillips Drive



Material : Steel hardened  
 Finish : Black  
 Drive : Phillips Drive

S.No.	Description	Suitable for	Article No.	Unit	PU	MRP/Pc
1	PHD - 2 Screw Drive Bits H1 / 4*65mm PH2	3.5 - 5 mm dia	9 273 246 00	Pc	10	80

### Screws Driver



Material : Steel hardened  
 Drive : Pozi Drive

S.No.	Description	Suitable for	Dimension	Article No.	Unit	PU	MRP/Pc
1	Screws Driver	3.5 - 5 mm dia	PZ 2	9 193 260 00	Pc	1	200

\*Subject to stock availability / on request basis



# Furniture Fittings

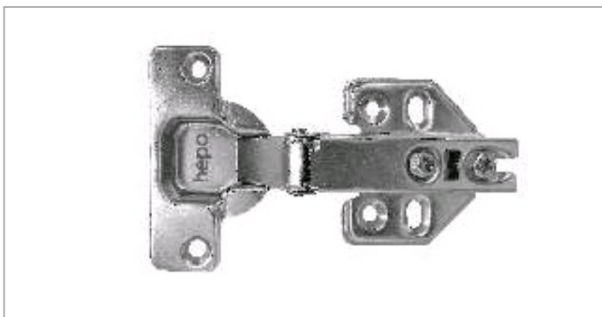

Reliable Concealed hinge: **Auto Close & Integrated Soft Close**  
 With Auto close as well as with Integrated Soft close feature  
 Tested & Certified for 20,000 Cycles & 24 hrs Salt Spray



Heavy Duty Drawer Runners: **Hepo Telescopic Drawer Runners**  
 With Options for Zinc Coated and Black Painted  
 Tested & Certified for 25,000 Cycles



High quality Wire basket: **Hepo Wire Basket**  
 Tested and certified for 5 years of structural and rust free warranty  
 Compatible with telescopic channels

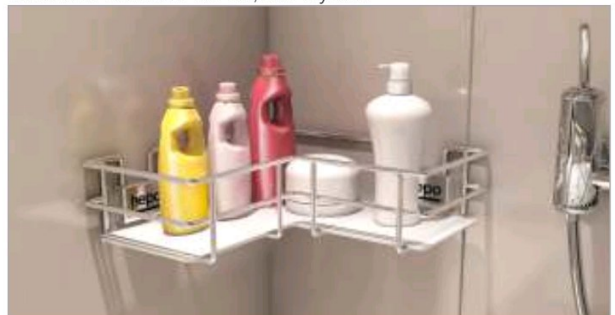

Hepo takes the definition of a contemporary bathroom a step ahead with its exquisite range of bathroom accessories that impart a sense of style and convenience to bathrooms

# Hepo Auto Close & Integrated Soft Close Hinge



## Auto Close & Integrated Soft Close Hinge

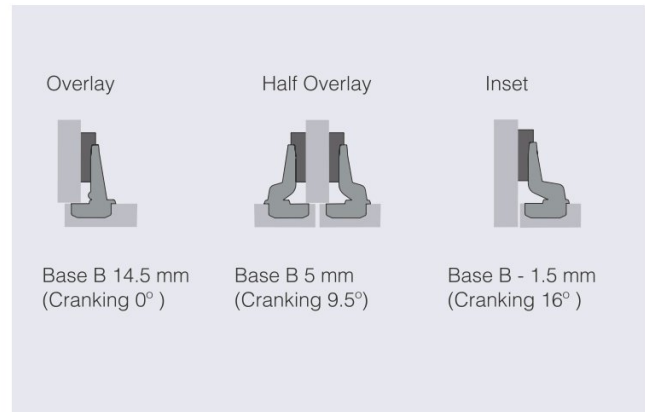

### Technical details:

- ▶ Concealed hinge with slide on assembly
- ▶ Quality classification under EN 15570, Level 1
- ▶ Tested & Certified for 20,000 Cycles & 24 hrs Salt Spray
- ▶ For door thickness 14 - 25 mm
- ▶ Opening angle: 105°
- ▶ Cup diameter 35 mm
- ▶ Cup depth 11.5 mm
- ▶ Integrated overlay adjustment + 0.5 mm / - 2.5 mm
- ▶ Integrated depth adjustment + 2 mm / - 2 mm
- ▶ Height adjustment at mounting plate
- ▶ Hinge arm material: Steel, Nickel plated

### Minimum Reveal Per Door

0° J Á 0° 0° 0° 0°	0° (1/2) 0°											
Á	F	Fí	Fí	Fí	Fí	FJ	0°	0°	0°	0°	0°	0°
H	0°	0°	0°	0°	0°	0°	0°	0°	0°	0°	0°	0°
I	0°	0°	0°	0°	0°	0°	0°	0°	0°	0°	0°	0°
I 0°	0°	0°	0°	0°	0°	0°	0°	0°	0°	0°	0°	0°
i	0°	0°	0°	0°	0°	0°	0°	0°	0°	0°	0°	0°
i	0°	0°	0°	0°	0°	0°	0°	0°	0°	0°	0°	0°
i	0°	0°	0°	0°	0°	0°	0°	0°	0°	0°	0°	0°
i	0°	0°	0°	0°	0°	0°	0°	0°	0°	0°	0°	0°

### Auto Close Hinge (Opening angle 105°)

Description (Industrial Packing)	Unit	Article no.	PU	MRP/Pc
Auto Close Hinge - 0° Crank	Pc	9 284 697 00	200	64
Auto Close Hinge - 9.5° Crank	Pc	9 284 698 00	200	69
Auto Close Hinge - 16° Crank	Pc	9 284 809 00	200	74

### Integrated Soft Close Hinge (Opening angle 105°)

Description (Industrial Packing)	Unit	Article no.	PU	MRP/Pc
Integrated Soft Close Hinge - 0° Crank	Pc	9 284 810 00	200	134
Integrated Soft Close Hinge - 9.5° Crank	Pc	9 284 811 00	200	139
Integrated Soft Close Hinge - 16° Crank	Pc	9 284 812 00	200	144

### Hinge Mounting Plate (Opening angle 105°)

Description (Industrial Packing)	Unit	Article no.	PU	MRP/Pc
Mounting Plate with two fixing holes, D=0 mm	Pc	9 284 813 00	200	15
Mounting Plate with four fixing holes, D=0 mm	Pc	9 284 814 00	200	15

# Hepo Auto Close & Integrated Soft Close Hinge



## Auto Close Hinge with Mounting Plate (2 hole)

- Technical details:
- ▶ Set Consists of:
    - 2 Hinges
    - 2 Mounting Plates (2 Hole)



Auto Close Hinge with Mounting Plate (2 hole), D=0 mm

Description (Retail Packing)	Unit	Article no	PU	MRP/Pair
Auto Close Hinge - 0° Crank with mounting plate (2 hole)	Pair	9 284 697.M2	100	79
Auto Close Hinge - 9.5° Crank with mounting plate (2 hole)	Pair	9 284 698.M2	100	84
Auto Close Hinge - 16° Crank with mounting plate (2 hole)	Pair	9 284 809.M2	100	89

## Auto Close Hinge with Mounting Plate (4 hole)

- Technical details:
- ▶ Set Consists of:
    - 2 Hinges
    - 2 Mounting Plates (4 Hole)

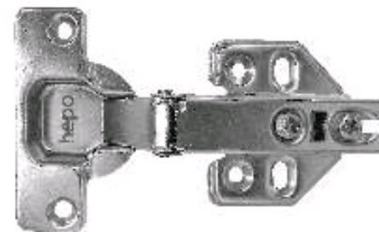

Auto Close Hinge with Mounting Plate (4 hole), D=0 mm

Description (Retail Packing)	Unit	Article no	PU	MRP/Pair
Auto Close Hinge - 0° Crank with mounting plate (4 hole)	Pair	9 284 697.M4	100	79
Auto Close Hinge - 9.5° Crank with mounting plate (4 hole)	Pair	9 284 698.M4	100	84
Auto Close Hinge - 16° Crank with mounting plate (4 hole)	Pair	9 284 809.M4	100	89

## Integrated Soft Close Hinge, Mounting Plate (2 hole)

- Technical details:
- ▶ Set Consists of:
    - 2 Hinges
    - 2 Mounting Plates (2 Hole)

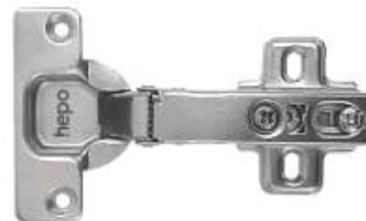

Integrated Soft Close Hinge with Mounting Plate (2 hole), D=0 mm

Description (Retail Packing)	Unit	Article no	PU	MRP/Pair
Integrated Soft Close Hinge - 0° Crank with mounting plate (2 hole)	Pair	9 284 810.M2	100	149
Integrated Soft Close Hinge - 9.5° Crank with mounting plate (2 hole)	Pair	9 284 811.M2	100	154
Integrated Soft Close Hinge - 16° Crank with mounting plate (2 hole)	Pair	9 284 812.M2	100	159

## Integrated Soft Close Hinge, Mounting Plate (4 hole)

- Technical details:
- ▶ Set Consists of:
    - 2 Hinges
    - 2 Mounting Plates (4 Hole)

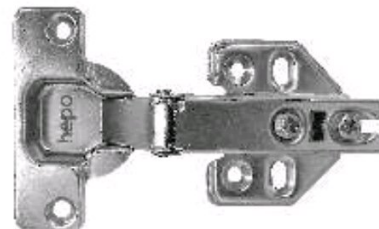

Integrated Soft Close Hinge with Mounting Plate (4 hole), D=0 mm

Description (Retail Packing)	Unit	Article no	PU	MRP/Pair
Integrated Soft Close Hinge - 0° Crank with mounting plate (4 hole)	Pair	9 284 810.M4	100	149
Integrated Soft Close Hinge - 9.5° Crank with mounting plate (4 hole)	Pair	9 284 811.M4	100	154
Integrated Soft Close Hinge - 16° Crank with mounting plate (4 hole)	Pair	9 284 812.M4	100	159

# Hepo Telescopic Channel

## Heavy Duty Drawer Runners



### Telescopic Channel - Zinc / Black



**Features:**

- ▶ Heavy Duty full extension runner
- ▶ Guaranteed up to 25,000 Opening-closing cycles
- ▶ Better Designed Tracks creates Ease of operation & Better dynamic Load Behaviour
- ▶ Loading Capacity: 45 kg



Description	Size	Unit	Article no	PU	MRP / Pair
Hepo Telescopic Channel /Zinc	10"- 250 mm	Set	9 284 648 00	10	249
Hepo Telescopic Channel /Zinc	12"- 300 mm	Set	9 284 699 00	10	279
Hepo Telescopic Channel/Zinc	14"- 350 mm	Set	9 284 700 00	10	309
Hepo Telescopic Channel/Zinc	16"- 400 mm	Set	9 284 701 00	10	339
Hepo Telescopic Channel/Zinc	18"- 450 mm	Set	9 284 702 00	10	369
Hepo Telescopic Channel/Zinc	20"- 500 mm	Set	9 284 703 00	10	399
Hepo Telescopic Channel/Zinc	22"- 550 mm	Set	9 284 704 00	10	429



Description	Size	Unit	Article no	PU	MRP / Pair
Hepo Telescopic Channel /Black	10"- 250 mm	Set	9 284 705 00	10	249
Hepo Telescopic Channel /Black	12"- 300 mm	Set	9 284 706 00	10	279
Hepo Telescopic Channel/Black	14"- 350 mm	Set	9 284 707 00	10	309
Hepo Telescopic Channel/Black	16"- 400 mm	Set	9 284 708 00	10	339
Hepo Telescopic Channel/Black	18"- 450 mm	Set	9 284 709 00	10	369
Hepo Telescopic Channel/Black	20"- 500 mm	Set	9 284 710 00	10	399

# Hepo Wire Basket

High quality stainless steel baskets with chrome plating  
Compatible with Telescopic Channels



## Plain Basket



- ▶ Unique sleek elegant design
- ▶ 30 kg weight carrying capacity
- ▶ Convenient to store different size packs of your kitchen

Article No.	Size WxDxH: mm(inch)	Unit	PU	MRP/Pc
9 280 319 00	380x500x100 (15"x20"x4")	Pc	6	1,492
9 280 320 00	380x500x150 (15"x20"x6")	Pc	4	1,809
9 280 351 00	380x500x200 (15"x20"x8")	Pc	3	2,057
9 280 354 00	430x500x100 (17"x20"x4")	Pc	6	1,560
9 280 355 00	430x500x150 (17"x20"x6")	Pc	4	1,843
9 280 356 00	430x500x200 (17"x20"x8")	Pc	3	2,251
9 280 359 00	480x500x100 (19"x20"x4")	Pc	6	1,642
9 280 360 00	480x500x150 (19"x20"x6")	Pc	4	1,982
9 280 361 00	480x500x200 (19"x20"x8")	Pc	3	2,354
9 280 364 00	530x500x100 (21"x20"x4")	Pc	6	1,518
9 280 365 00	530x500x150 (21"x20"x6")	Pc	4	1,822
9 280 366 00	530x500x200 (21"x20"x8")	Pc	3	2,126

## Cup & Saucer Basket



- ▶ Sleek design for perfect arrangement of cup & saucers
- ▶ Recommended shutter height min. 180 mm
- ▶ 500 mm depth can hold 18 no. of saucers  
380 mm width can hold 8 no. of cups & 530 mm can hold 16 no. of cups respectively

Article No.	Size WxDxH: mm(inch)	Unit	PU	MRP/Pc
9 280 352 00	380x500x100 (15"x20"x4")	Pc	6	1,866
9 280 357 00	430x500x100 (17"x20"x4")	Pc	6	2,089
9 280 362 00	480x500x100 (19"x20"x4")	Pc	6	2,538
9 280 367 00	530x500x100 (21"x20"x4")	Pc	6	2,538

## Thali Basket



- ▶ Compact design to store thalis in an organized manner
- ▶ Recommended shutter height min. 360 mm
- ▶ 500 mm depth can hold 11 no. of thalis

Article No.	Size WxDxH: mm(inch)	Unit	PU	MRP/Pc
9 280 353 00	380x500x150 (15"x20"x6")	Pc	4	2,237
9 280 358 00	430x500x150 (17"x20"x6")	Pc	4	2,425
9 280 363 00	480x500x150 (19"x20"x6")	Pc	4	2,640
9 280 368 00	530x500x150 (21"x20"x6")	Pc	4	2,698

# Bathroom Accessories

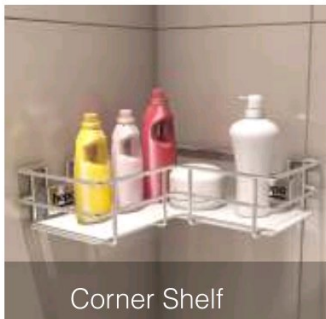

Corner Shelf

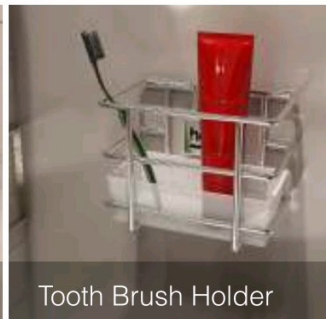

Tooth Brush Holder



Soap & Shampoo Holder

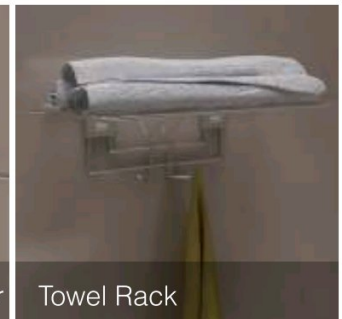

Towel Rack

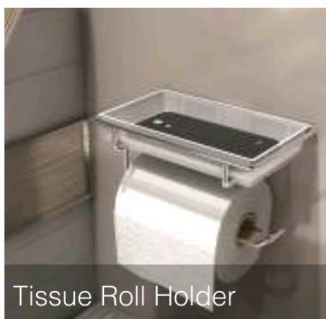

Tissue Roll Holder

Hepo takes the definition of a contemporary bathroom a step ahead with its exquisite range of bathroom accessories that impart a sense of style and convenience to bathrooms. The range consists of a set of accessories that provide holistic solutions to every possible storage need in the bathroom. The accessories not only add on style to your bathroom but also enhance the level of convenience.

## Hepo Bathroom Accessories

Superior quality stainless steel accessories with chrome plating  
5 years replacement warranty against rusting

hepo



### Accessory Shelf



Hepo Accessory Shelf has been modelled to hold daily use assortments. When added to the bathroom ensemble, the linear designed shelf adds a subtle refined touch.

- ▶ Package contains 1 accessory shelf, 1 plastic tray, 2 cover caps & 5 wall fixing screws
- ▶ Can hold a variety in bottles of different sizes

Description	Article No.	Size (WxDxH) mm	MRP
Accessory Shelf - W300	9 280 369 00	300x100x120	1,043
Accessory Shelf - W450	9 280 370 00	450x100x120	1,232

### Corner Shelf



Hepo Corner Shelf is a sleek corner unit that can hold multiple essential stuff. The product enhances storage space with its L shape component not only in your bathroom but can also be used in other corners of your beautiful house.

- ▶ Package contains 1 corner shelf, 1 plastic tray, 2 cover caps & 5 wall fixing screws
- ▶ Can hold a variety of bottles in different sizes with other articles as well

Description	Article No.	Size(WxDxH) mm	MRP
Corner Shelf	9 280 372 00	300x300x120	1,328

### Hand Towel Holder



Hepo Hand Towel Holder is a charming accessory geared to store the towels. The product helps to retain a high level hygiene factor in the bathroom by keeping the towels dry and gives a pleasant contemporary twist to the bathroom landscape.

- ▶ Package contains 1 hand towel holder, 1 cover cap & 3 wall fixing screws
- ▶ Can hold 2 hand towels

Description	Article No.	Size (WxDxH) mm	MRP
Hand Towel Holder - 220 mm	9 280 373 00	220x70x100	568

## Hepo Bathroom Accessories

Superior quality stainless steel accessories with chrome plating  
5 years replacement warranty against rusting

# hepo



### Towel Rail



Hepo Stainless Steel Towel Rails adds a refined touch to the bathroom. It is a cool practical home addition that keeps your towel dry that keeps the sick humid stink at bay. A must for your bathroom, they add the right glamour touch & keep your bathroom free of damp breeding ground for germs and mold.

- ▶ Package contains 1 towel rail, 2 cover caps & 5 wall fixing screws
- ▶ Can hold 2 hand towels

Description	Article No.	Size (WxDxH) mm	MRP
Towel Rail - 350 mm	9 280 378 00	350x100x100	852

### Towel Rack



Hepo wall mounted Towel Rack adds the right stylish element to your bathroom. It lets you stack your towels neatly on to it which looks good, gives you great comfort & keeps your bathroom hygienic too!

- ▶ Package contains 1 towel rack, 2 cover caps & 5 wall fixing screws
- ▶ Can hold 3 folded towels on the surface & 3 towels or clothes can be hung

Description	Article No.	Size (WxDxH) mm	MRP
Towel Rack - 450 mm	9 280 377 00	450x250x150	2,466

### Clothes Hook



Hepo Clothes Hook is a fascinating and convenient clothes holder fashioned to hold the clothes in the bathroom in style. The product puts an end to the unsightly picture of used and unused clothes lying around, in the bathroom by giving a compact place to hang them.

- ▶ Package contains 1 cloth hook, 2 cover caps & 5 wall fixing screws
- ▶ Can hold 9 nos of clothes or full size towels

Description	Article No.	Size (WxDxH) mm	MRP
Clothes Hook	9 280 371 00	447x55x133	1,138



## Hepo Bathroom Accessories

Superior quality stainless steel accessories with chrome plating  
5 years replacement warranty against rusting

# hepo



### Tooth Brush Holder



Hepo stainless steel Tooth Brush Holder adds the right ambivalent touch to your bathroom, saves the unnecessary utilization of space by toothbrush containers on the basin.

- ▶ Package contains 1 tooth brush holder, 1 plastic tray, 1 cover cap & 3 wall fixing screws
- ▶ Can hold 4-6 toothbrushes, tongue cleaner & 1 toothpaste tube / mouth freshener

Description	Article No.	Size (WxDxH) mm	MRP
Tooth Brush Holder	9 280 376 00	150x100x70	757

### Soap & Shampoo Holder



Hepo Soap & Shampoo Holder is another accessory from Hepo that allows you to place your favourite shampoo and soap in a way that is conveniently accessible. The holder prevents the wastage of space on the floor or open spaces that may be taken up in absence of the wall mounted holder.

- ▶ Package contains 1 soap holder, 1 plastic tray, 1 cover cap & 3 wall fixing screws
- ▶ Can hold 1 soap and 1 shampoo bottle or shower gel bottom hook can be hold loofah or bath scrubber

Description	Article No.	Size (WxDxH) mm	MRP
Soap & Shampoo Holder	9 280 374 00	200x115x125	948

### Tissue Roll Holder



Hepo Tissue Roll Holder with plastic tray is a suave product that must find a place in all modern bathrooms to maintain that elite factor besides maintaining hygiene within. It rolls the tissues well that comes out with ease while in use.

- ▶ Package contains 1 tissue roll holder, 1 plastic tray, 1 cover cap & 3 wall fixing screws
- ▶ Can hold 1 tissue roll and some other articles on plastic tray

Description	Article No.	Size (WxDxH) mm	MRP
Tissue Roll Holder	9 280 375 00	200x105x110	1,138

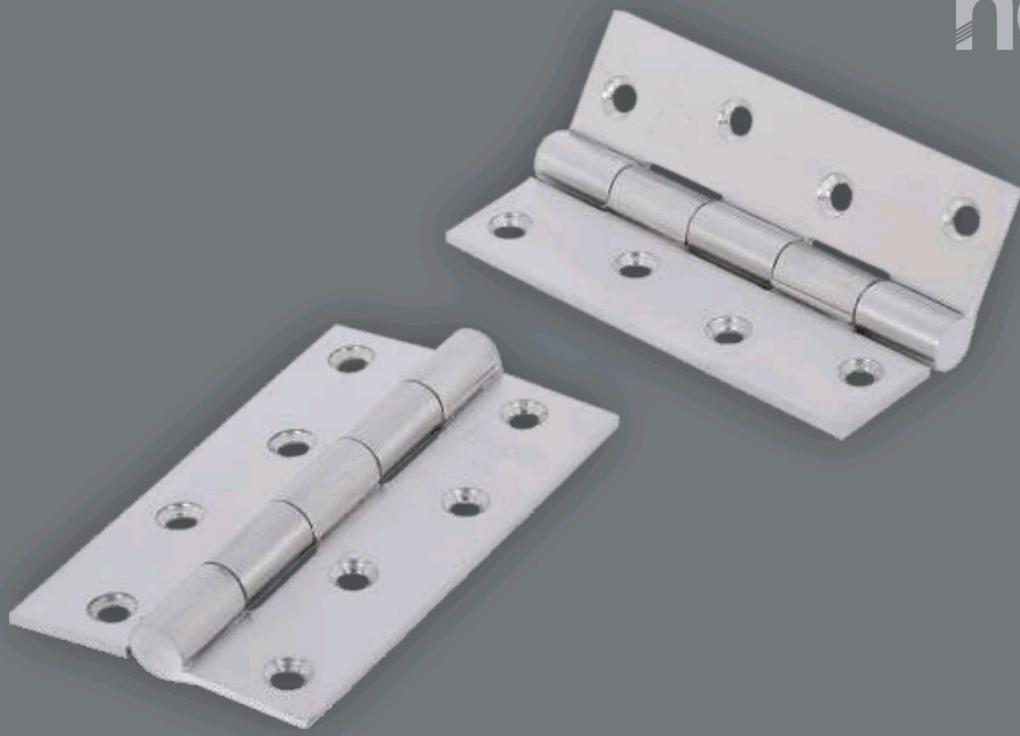

# Door Hinges



Butt Hinge option for **Pin Type Riveted** as well as **Welded (Railway)** Hinge. High Weight carrying capacity up to 40 kg (per pair). Tested and Warranted for 2 years of functionality



## Hepo Butt Hinges

Riveted Type

### SS Riveted Type



#### Features:

- ▶ Loading Capacity up to 40 kg / pair
- ▶ DIN Left/Right Usable
- ▶ Mostly preferred for Steel / wood & Aluminum profile doors
- ▶ Area of application: Light Main and Internal doors
- ▶ Warranty : 2 years

#### Technical details:

- ▶ Ø Barrel diameter: 12 mm
- ▶ Leaf thickness: 2.5 mm
- ▶ Milling for doors: 2 / 2.5 mm
- ▶ Available Sizes: 3"x2"x2 mm/4"x3"x2.5 mm/5"x3"x2.5 mm
- ▶ Base Material: Stainless Steel
- ▶ Edge: Square
- ▶ Finish Available: Stainless Steel Satin

S.No.	Description: Size mm (inch)	Unit	Article No.	PU	MRP / Pair
1	SS 76x50x2 mm (3"x2"x2 mm) (Hole Pattern: C)	Pair	9 268 550	01	265
2	SS 102x76x2.5 mm (4"x3"x2.5 mm) (Hole Pattern: Z)	Pair	9 268 395	01	373
3	SS 127x76x2.5 mm (5"x3"x2.5 mm) (Hole Pattern: Z)	Pair	9 268 396	01	435

# Hepo Butt Hinges

Welded Type

# hepo



## SS Welded Type (Railway Hinges)



### Features:

- ▶ Recommended for wooden / aluminium / framed doors.
- ▶ Area of application: Main and Internal doors of an apartment / building
- ▶ Warranty - 2 years

### Technical details:

- ▶ Leaf Thickness - 1.7 / 2 / 2.5 mm
- ▶ Edge - Square Edge
- ▶ Pin Dia - 4 & 5.6mm
- ▶ DIN Left/Right Usage
- ▶ Available Sizes:- 3x14 / 4x14 / 5x14 / 3x12 / 4x12 / 5x12
- ▶ Finish Available - SS Satin
- ▶ No. of Holes - 6/8

S.No.	Description: Size mm (inch)	Unit	Article No.	PU	MRP/Pair
1	Butt Hinge SS 75 X 48X 1.9mm (3x14)	Pair	9 278 616 00	20	135
2	Butt Hinge SS 100 X 58 X 1.9mm (4x14)	Pair	9 278 617 00	12	215
3	Butt Hinge SS 125 X 64 X 1.9mm (5x14)	Pair	9 278 618 00	10	280
4	Butt Hinge SS 75 X 50 X 2.5mm (3x12)	Pair	9 278 619 00	20	165
5	Butt Hinge SS 100 X 60 X 2.5mm (4x12)	Pair	9 278 620 00	12	250
6	Butt Hinge SS 125 X 67 X 2.5mm (5x12)	Pair	9 278 621 00	10	330

**he  
po**

*Retail Products*

# Furniture Fittings



Roller runner available with integrated soft closing & roll-out prevention. Suitable for using in easy to remove wooden drawer in kitchen, bathroom & office furniture.

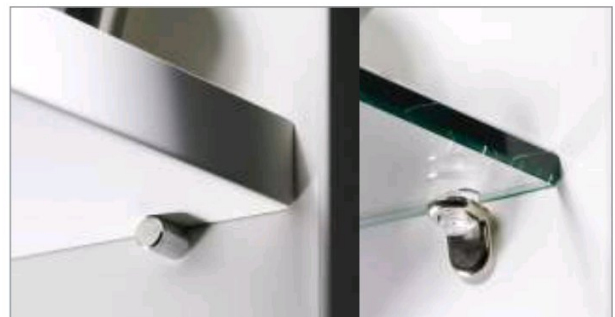

Firm & secure support elements work more than shelf support- like being accidentally lifted or pulled out & from tipping or slipping out. Easy to fit solution for any design of furniture.



Trendy handles available with different design & finishes. Used in commercial & domestic furniture.



Single Skin Metal Box with integrated roller runner channel. Available in 3 different heights: 54 mm, 86 mm, 118 mm. It is useful in wealth of applications like kitchen, bathroom & office furniture.

## FR 302



### Features:

- ▶ Stop Control-integrated self-closing mechanism for automatic closure
- ▶ With double-stop and roll-out guard
- ▶ with captive guide rail on one side

### Technical details:

- ▶ Automatic tolerance compensation  $\pm 1$  mm
- ▶ Loading capacity to EN 15338, Level 1
- ▶ Powder-coated steel, white



Description	Size	Article no.	Unit	PU	MRP/Pair
FR 302 Roller Runner	250 mm	0 075 993	Set	20	95
FR 302 Roller Runner	300 mm	0 075 994	Set	20	103
FR 302 Roller Runner	350 mm	0 075 995	Set	20	115
FR 302 Roller Runner	400 mm	0 075 996	Set	20	129
FR 302 Roller Runner	450 mm	0 075 997	Set	20	143
FR 302 Roller Runner	500 mm	0 013 089	Set	20	157
FR 302 Roller Runner	550 mm	9 006 351	Set	20	173

## Single Skin Metal Box

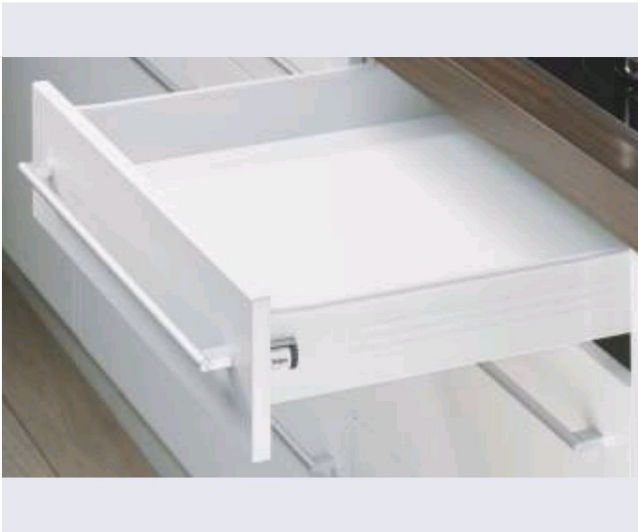

**Features:**

- ▶ Weight capacity : 25 kg
- ▶ Partial extension
- ▶ Finish : Powder Coated White
- ▶ With Integrated Roller Channel system
- ▶ Compatible with Multi Drawer Lock from Hettich Range

**Features:**

- ▶ Heights available are 54 mm, 86 mm & 118 mm
- ▶ Nominal Length of 400 mm
- ▶ Roller Material- Acetal homopolymer which is higher tensile and impact strength
- ▶ Connector included in package
- ▶ Tested and certified for 20,000 cycles
- ▶ Lifetime Functional Warranty

Description	Size	Article no	Unit	PU	MRP
Single Skin Metal Box	86x400 mm	9 279 509	Set	10	308
Single Skin Metal Box	118x400 mm	9 279 515	Set	10	343
Single Skin Metal Box	54x400 mm	9 284 832	Set	10	274
Brand Cap for MT (MT-TPE101)	—	9 250 745	Set	10	1.17
Lock Component MT (MT-TPE102)	—	9 250 753	Set	10	2.35



## Wooden shelf support

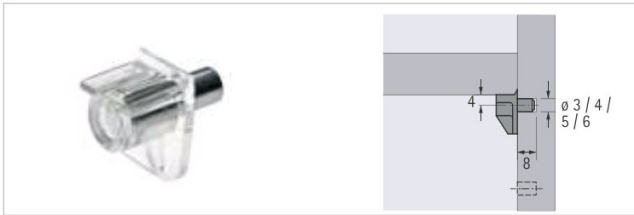

### Safety

- ▶ Steel pin with plastic support surface
- ▶ Can be used in System 32
- ▶ Load group L 50 (50 kg / m<sup>2</sup>) Translucent

For drill hole diameter mm	Article No.	Unit	PU	MRP/100
5	0 016 180	Pc	1000	277

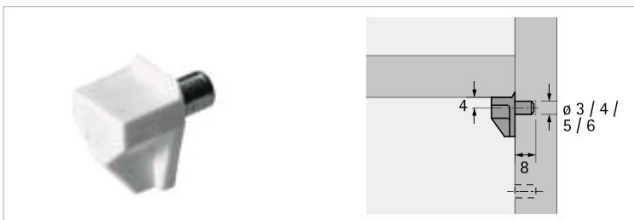

### Safety

- ▶ Steel pin with plastic support surface
- ▶ Can be used in System 32
- ▶ Load group L 50 (50 kg / m<sup>2</sup>) White

For drill hole diameter mm	Article No.	Unit	PU	MRP/100
5	0 025 090	Pc	1000	277

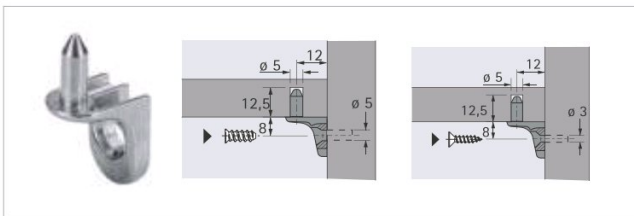

### Sekura 7

- ▶ Drill hole diameter 5 mm for direct fixing screw
- ▶ Countersunk head Dia 6.3 mm
- ▶ Zinc die-cast, nickel plated
- ▶ Load group L 75 (75 kg / m<sup>2</sup>)

For drill hole diameter mm	Article No.	Unit	PU	MRP/100
5	0 053 012	Pc	1000	1,039



### Universal D

- ▶ Pin diameter 5 mm
- ▶ Can be used in System 32
- ▶ Load group L 75 (75 kg/m<sup>2</sup>)
- ▶ Zinc die-cast nickel-plated

Article No.	Unit	PU	MRP/100
0 22 737	Pc	1000	554

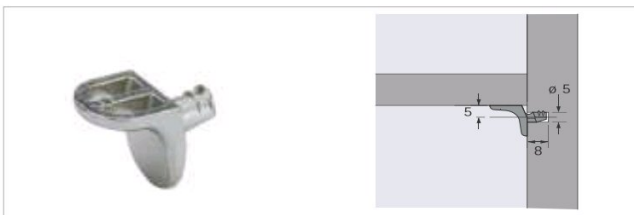

- ▶ Pin diameter 5 mm
- ▶ Die-cast zinc nickel-plated
- ▶ Can be used in System 32
- ▶ Load group L 75 (75 kg / m<sup>2</sup>)

Article No.	Unit	PU	MRP/100
0 025 100	Pc	1000	600



### Sekura 6

- ▶ Pin diameter 5 mm
- ▶ 1 additional pin for shelf
- ▶ Can be used in System 32
- ▶ Load group L 75 (75 kg/m<sup>2</sup>)
- ▶ Zinc die-cast nickel plated

Article No.	Unit	PU	MRP/100
0 79 707	Pc	1000	1,014

## Wooden shelf support



- Sekura 1.1**
- ▶ Pin diameter 5 mm
  - ▶ 1 additional pin for shelf
  - ▶ Die-cast zinc nickel-plated
  - ▶ Can be used in System 32

Article No.	Unit	PU	MRP/100
0 019 557	Pc	1000	662



- Titan**
- ▶ Concealed installation behind the shelf
  - ▶ Bolt: 10 mm A/F
  - ▶ Max. loading capacity is 50 kg/m<sup>2</sup> for shelves measuring 1000 x 300 mm, 100 kg/m<sup>2</sup> for shelves measuring 1000 x 250 mm and 160 kg/m<sup>2</sup> for shelves measuring 1000 x 200 mm
  - ▶ Height adjustment: ± 4 mm
  - ▶ Minimum shelf thickness: 24 mm
  - ▶ Adjustment of shelf slope
  - ▶ Galvanised steel
  - ▶ Fixing screws (Order No. 0 065 480)

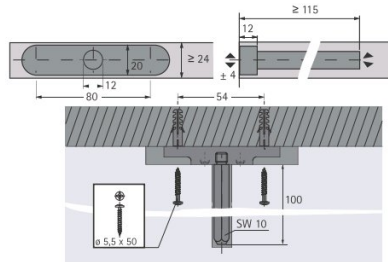
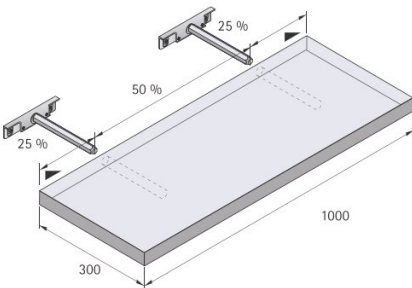

Article No.	Unit	PU	MRP/100
0 047 661	Pc	20	9,100

## Glass shelf support

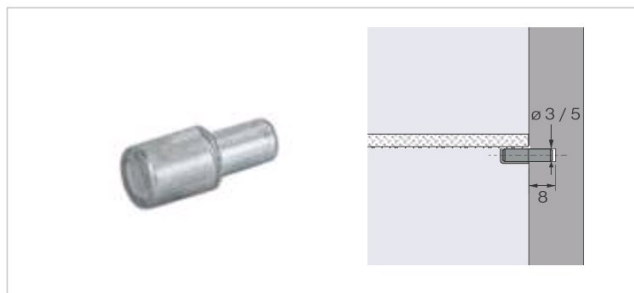

- Glass shelf supports, Perfekt**
- ▶ With soft plastic cap
  - ▶ Galvanised steel / clear plastic
  - ▶ Load group L 50 (50 kg / m<sup>2</sup>)

For drill hole diameter mm	Article No.	Unit	PU	MRP/100
5	0 079 709	Pc	1000	277



- Sekura 8**
- ▶ Pin diameter 5 mm
  - ▶ Zinc die-cast nickel-plated / Plastic transparent
  - ▶ Can be used in System 32
  - ▶ Load group L 75 (75 kg / m<sup>2</sup>)

Article No.	Unit	PU	MRP/100
0 047 609	Pc	1000	1,234

## Magnetic push catches M 72 /GP 2



Technical details:

- ▶ Holding force 4 kg
- ▶ Housing: plastic
- ▶ Rigid counterplate, galvanised steel

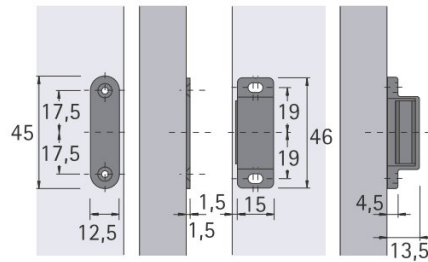

Finish	Article No.	Unit	PU	MRP
Brown	0 013 142	Pc	50	53

## Multipurpose Lock



- ▶ Multipurpose lock with manual operation
- ▶ Suitable for furniture small wooden closets, drawers etc

Finish	Article No.	Unit	PU	MRP
Multipurpose drawer square lock 22 mm	4 363 5	Pc	100	195
Multipurpose drawer square lock 32 mm	9 110 389 00	Pc	100	205

## Cylinder push Lock



- ▶ Suitable for Sliding doors
- ▶ Complete with rosette
- ▶ Nickel-plated

Type	Article No.	Unit	PU	MRP
Push lock with 22 mm	9 180 613	Pc	200	175
Push lock with 32 mm	9 182 732	Pc	200	213

# Locks

## Fixed Barrel Cam Lock



### Cylinder cam lock (Fixed Barrel)- 2 mm cranked



- ▶ With installed bolt, 2 mm cranked
- ▶ Right hand drawer locking (depending on installation situation)
- ▶ Complete with rosette
- ▶ Nickel plated

Set comprises:

- ▶ 1 rosette, 1 striker plate
- ▶ Cam lock, 2 mm cranked

Description	Article No.	Unit	PU	MRP
Cylinder cam lock set	9 227 175 00	Set	1	155

### Cylinder cam lock (Fixed Barrel)- 11 mm cranked



- ▶ With installed bolt, 11 mm cranked
- ▶ Right hand drawer locking (depending on installation situation)
- ▶ Complete with rosette
- ▶ Nickel plated

Set comprises:

- ▶ 1 rosette, 1 striker plate
- ▶ Cam lock, 11 mm cranked

Description	Article No.	Unit	PU	MRP
Cylinder cam lock set	9 227 177 00	Set	1	155

### Cylinder cam lock (Fixed Barrel)- Flat cam



- ▶ With installed bolt, Flat cam
- ▶ Right hand drawer locking (depending on installation situation)
- ▶ Complete with rosette
- ▶ Nickel plated

Set comprises:

- ▶ 1 rosette, 1 striker plate
- ▶ Flat Cam lock

Description	Article No.	Unit	PU	MRP
Cylinder cam lock set	9 227 176 00	Set	1	155

Sr. no.	Description	Hole Distance	Finish	Article No	Unit	PU	MRP/Pc
1.	 Adonia	96	Nickel Matt	1 180 122 00	Pc	200	87
		128	Nickel Matt	1 180 121 00	Pc	150	135
2.	 Alano	96	Nickel Matt	1 180 167 00	Pc	200	92
		128	Nickel Matt	1 180 166 00	Pc	125	136
3.	 Ancona	96	Nickel Matt	1 161 173 00	Pc	60	82
		128	Nickel Matt	1 161 167 00	Pc	50	122
4.	 Agacia	96	Nickel Matt	9 220 976 00	Pc	50	69
		128	Nickel Matt	9 220 978 00	Pc	50	108
5.	 Agacia	96	Bright Chrome	9 220 975 00	Pc	50	62
		128	Bright Chrome	9 220 977 00	Pc	50	99
6.	 Andera	96	Nickel Matt	9 220 980 00	Pc	50	64
		128	Nickel Matt	9 220 982 00	Pc	50	112
7.	 Andera	96	Bright Chrome	9 220 979 00	Pc	50	58
		128	Bright Chrome	9 220 981 00	Pc	50	103

# Bed Fitting Mechanism

Effortless Function - Long life



Hepo's range of Bed Storage Systems addresses the need of space-efficiency. It offers a complete and effective solution for accessing the storage spaces below the heavy mattresses with ease. Most Indian households store bed linen, pillows & blankets which are required for seasonal purposes underneath their mattresses in the bed storage.

Hepo Bed Fittings allow to access the storage with ease and a swift single handed lift movement.

The opening angle of the fitting is also engineered to provide maximum access to the storage space from all sides of the bed.

The Bed Lift Storage System is the answer to all storage needs; it is a smart solution for turning a cluttered master bedroom into a relaxing retreat which allows Complete Opening Function for Ergonomical needs. It is designed specially keeping in mind the current Indian housing scenario and is the perfect way to add more usable living space to your room.



Side Opening Bed Storage



Bed Fittings Fixed to Sides of Storage



Centrally Fixed Fittings for clear sides

# Hepo Bed Fitting Mechanism

Bed Fitting Frame



## Technical Specification

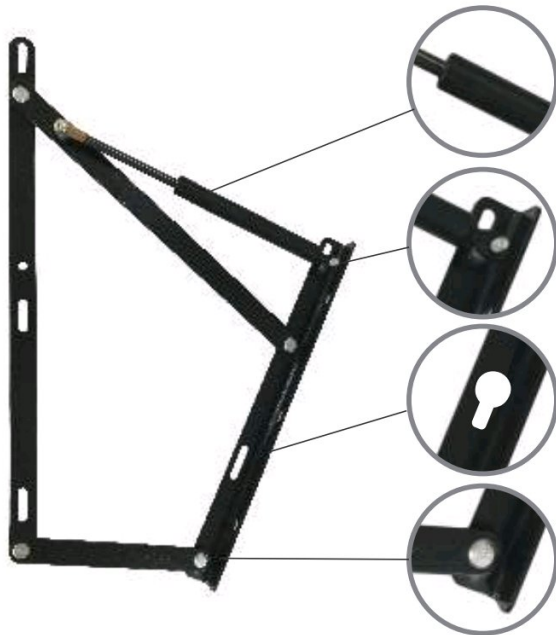

- ▶ Perfect Storage & Space saving
- ▶ Large opening for easy access under the bed
- ▶ Opening from the side or foot of the bed is workable
- ▶ Convenience of use
- ▶ Noiseless and effortless operation
- ▶ International quality mechanism
- ▶ Black Powder Coated finish
- ▶ Backed by Hepo assurance
- ▶ Gas Spring: Passed SGS Test Reliable
- ▶ Quality Effortless Operation
- ▶ Frame Material : Q235
- ▶ Frame Thickness : 3 mm - 5 mm
- ▶ Finish: Powder Coated Black color

## Bed Fitting Frame - 405 mm

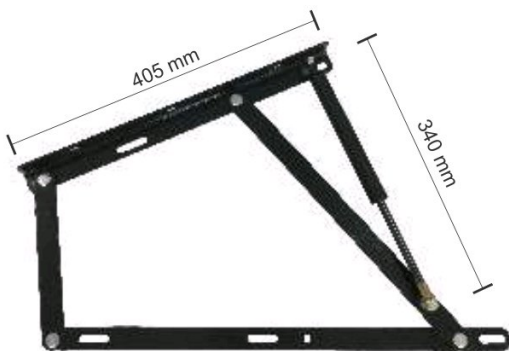

- ▶ Frame Material : Q235
- ▶ Frame Thickness : 3 mm
- ▶ Finish: Powder Coated Black color
- ▶ Maximum Opening Angle: 40°
- ▶ Compatible with Gas Spring of 340mm Length / 20kg

Description	Article No.	Unit	PU
Bed Fitting Frame - 405mm	9 263 452	Set	1
Gas Spring 340mm / 20Kg	9 263 458	Set	1

## Bed Fitting Frame - 590 mm

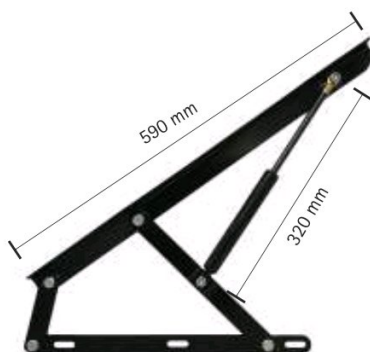

- ▶ Frame Material : Q235
- ▶ Frame Thickness : 3 mm
- ▶ Finish: Powder Coated Black color
- ▶ Maximum Opening Angle: 60°
- ▶ Compatible with Gas Spring of 320mm Length/30kg

Description	Article No.	Unit	PU
Bed Fitting Frame - 590 mm	9 263 453	Set	1
Gas Spring 320mm / 30Kg	9 263 459	Set	1

# Hepo Bed Fitting Mechanism

## Bed Fitting Frame



### Bed Fitting Frame - 1100 mm

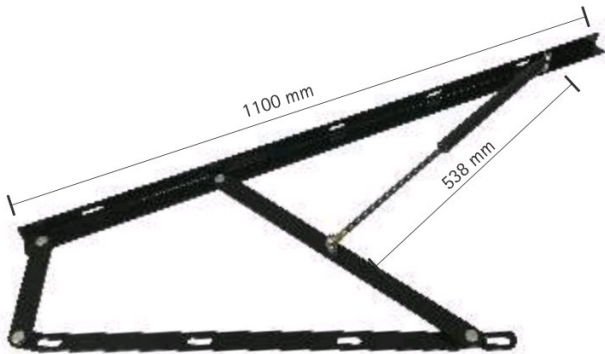

- ▶ Frame Material : Q235
- ▶ Frame Thickness : 5 mm
- ▶ Finish: Powder Coated Black color
- ▶ Maximum Opening Angle: 60°
- ▶ Compatible with Gas Spring of 538mm Length / 50kg /70kg

Description	Article No.	Unit	PU
Bed Fitting Frame - 1100mm	9 263 455	Set	1
Gas Spring 538mm / 50Kg	9 263 460*	Set	1
Gas Spring 538mm / 70Kg	9 263 461*	Set	1

### Bed Fitting Frame - 1500 mm

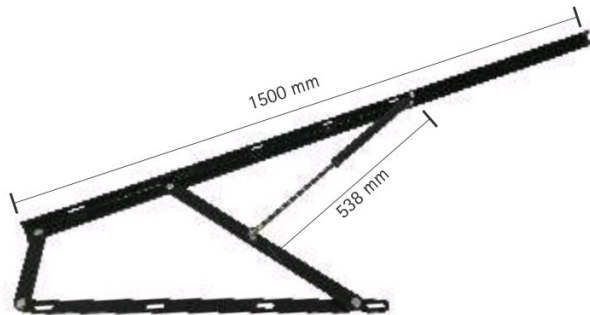

- ▶ Frame Material : Q235
- ▶ Frame Thickness : 5 mm/7 mm
- ▶ Finish: Powder Coated Black color
- ▶ Maximum Opening Angle : 60°
- ▶ Compatible with Gas Spring of 538mm Length/100kg/120kg/150kg/200kg

Description	Article No.	Unit	PU
Bed Fitting Frame -1500 mm	9 263 457	Set	1
Bed Fitting Frame -1500 mm plus	9 263 457 01	Set	1
Gas Spring Plus 538mm / 100Kg	9 263 462*	Set	1
Gas Spring Plus 538mm / 120Kg	9 263 463*	Set	1
Gas Spring Plus 538mm / 150Kg	9 264 940*	Set	1
Gas Spring Plus 538mm / 200Kg	9 266 309*	Set	1

### Mechanism & Gas Spring Codes

Description (Bed Lift Mechanism)	Article No.	Unit	PU	MRP/ Set
40° Q235 / 3mm Thk / 405 x 530mm / Black / Need 340mm Gas Spring	9 263 452	Set	1	1,582
60° Q235 / 3mm Thk / 590 x 400mm / Black / Need 320mm Gas Spring	9 263 453	Set	1	1,799
60° Q235 / 5mm Thk / 1100 x 620mm / Black / Need 538mm Gas Spring	9 263 455	Set	1	2,764
60° Q235 / 5mm Thk / 1500 x 620mm / Black / Need 538mm Gas Spring	9 263 457	Set	1	3,193
60° Q235 / 7mm Thk / 1500 Plus x 620mm / Black / Need 538mm Gas Spring	9 263 457 01	Set	1	3,193

Description (GAS SPRING)	Article No.	Unit	PU	MRP / Set
Gas Spring 340mm / 20Kg / Black / ø22mm / For Bed Fitting 405mm	9 263 458	Set	1	617
Gas Spring 320mm / 30Kg / Black / ø22mm / For Bed Fitting 590mm	9 263 459	Set	1	617
Gas Spring 538mm / 50Kg / Black / ø22mm / For Bed Fitting 1000-1500mm	9 263 460	Set	1	788
Gas Spring 538mm / 70Kg / Black / ø22mm / For Bed Fitting 1000-1500mm	9 263 461	Set	1	788
Gas Spring Plus 538mm / 100Kg / Black / ø28mm / For Bed Fitting 1000-1500mm	9 263 462	Set	1	788
Gas Spring Plus 538mm / 120Kg / Black / ø28mm / For Bed Fitting 1000-1500mm	9 263 463	Set	1	788
Gas Spring Plus 538mm / 150Kg / Black / ø28mm / For Bed Fitting 1000-1500mm	9 264 940	Set	1	1,362
Gas Spring Plus 538mm / 200Kg / Black / ø28mm / For Bed Fitting 1000-1500mm	9 266 309	Set	1	1,362

\* Gas Spring set to be ordered as per required weight capacity  
 \* Packaging: Each Bed Fitting and gas spring Set in a separate carton box  
 Note: MRP are subject to change any time without prior notice.



## Cargo Portable Dish Drainer

hepo



## Cargo Portable Dish Drainer



- ▶ Convenience of modular concept
- ▶ Can hold 5 Thali & 9 Plates
- ▶ Bottom mesh for holding utensils like spoons, forks, cups, bowls, glass, knives etc.
- ▶ Unique PVC collection tray
- ▶ Unique slotted plastic bottom for water draining
- ▶ Order PVC Tray & Plastic bottom separately
- ▶ 5 years warranty against rusting
- ▶ Width 505 mm / Depth 340 mm / Height 330 mm
- ▶ Finish- Chrome Plated

### Collecting Cargo PVC Tray 600 mm



- ▶ Optional PVC tray for water collecting
- ▶ Width 540 mm / Depth 270 mm / Height 25 mm
- ▶ Finish- Silver Plastic

### Acrylic sheet Portable Drainer



- ▶ Optional slotted plastic bottom for water draining
- ▶ Width 445 mm / Depth 230 mm / Thickness 3 mm
- ▶ Finish- White Plastic

S.no.	Description	Article No.	Unit	PU	MRP/Pc
1.	Cargo Portable Dish Drainer	9 267 212 00	Pc	1	2,530
2.	Collecting Cargo PVC Tray 600mm	9 190 453 00	Pc	1	295
3.	Acrylic sheet Portable Drainer	9 267 309 00	Pc	1	420

Square Bin Holder\*



- ▶ Major contribution in green environment management
- ▶ Finish: Chrome Plated

Technical Details

- ▶ Min required cabinet width- 350 mm
- ▶ Min. internal cabinet depth- 505 mm
- ▶ Preferable to use with Hinges 95° opening PTO
- ▶ Bin capacity- 7 L
- ▶ Shutter fixing with CTM fascia clamps

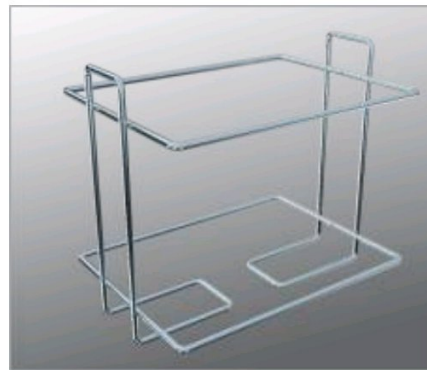

Description ( W x D x H) mm	Article no.	PU	MRP/Pc
Square Bin Holder (235 x 170x 205)	9 269 984	1 Pc	838

Round Bin Holder 200 Series\*



- ▶ Light weight but sturdy structure, as made of thick wire
- ▶ Easy installation, with fixing at only two points
- ▶ Disposable bags can be hung inside the frame directly
- ▶ Finish: Chrome Plated
- ▶ Made of stainless steel wire
- ▶ 10 years replacement warranty against rusting



Description	Article no.	PU	MRP/Pc
Round Bin Holder 200 Series	9 210 444	1 Pc	1,202

\*Bin to be purchased from market of matching dimension.



## Door Locks



Reliable door hardware consists of a range of cylindrical & knob locks.

The range has locking solution for:

- ▶ External & internal doors
- ▶ Bedroom & bathroom doors
- ▶ Balcony or one way access doors.

## Cylindrical Knob Locks



**Technical details:**

- ▶ Suitable door thickness: 30 mm – 45 mm
- ▶ Backset: 60 mm
- ▶ Function: Entrance/bathroom
- ▶ Material: Stainless steel
- ▶ Version: Cylinder with 5 pins
- ▶ Finish: Stainless Steel/Polished Brass/Antique Brass

**Set Includes:**

- 1 Knob lockset with latchbolt and striking plate
- 1 Special key for mounting the knobs
- 3 Keys (not in W/C version)

S.no.	Product Image	Description	Article No.	Unit	PU	MRP
1		HCK 01 SS: One side Key and one side knob (For Room Doors) (For Room Doors), with 3 keys, dia 65 mm	9 228 335	Set	1	827
2		HCK 01 SS WC: One side Knob and other side emergency release slot, without key (for Washroom doors), dia 65 mm	9 228 336	Set	1	750
3		HCK 01 SS BD: One side knob and other side Dead Knob (for Balcony doors), dia 65 mm	9 250 827	Set	1	783
4		HCK 01 PB: One side Key and one side knob (For Room Doors) (For Room Doors), with 3 keys, dia 65 mm	9 228 337	Set	1	1,004
5		HCK 01 PB WC: One side Knob and other side emergency release slot, without key (for Washroom doors), dia 65 mm	9 228 338	Set	1	927
6		HCK 01 PB BD: One side knob and other side Dead Knob (for Balcony doors), dia 65 mm	9 250 583	Set	1	937
7		HCK 01 AB: One side Key and one side knob (For Room Doors) (For Room Doors), with 3 keys, dia 65 mm	9 228 339	Set	1	1,004
8		HCK 01 AB WC: One side Knob and other side emergency release slot, without key (for Washroom doors), dia 65 mm	9 228 340	Set	1	927
9		HCK 01 AB BD: One side knob and other side Dead Knob (for Balcony doors), dia 65 mm	9 250 582	Set	1	937
10		HCK 02 SS: One side Key and one side knob (For Room Doors), with 3 keys, dia 75 mm	9 228 341	Set	1	949
11		HCK 02 SS WC: One side Knob and other side emergency release slot, without key (for bathroom doors), dia 75 mm	9 228 342	Set	1	872
12		HCK 02 PB: One side Key and one side knob (For Room Doors), with 3 keys, dia 75 mm	9 228 343	Set	1	1,453
13		HCK 02 PB WC: One side Knob and other side emergency release slot, without key (for bathroom doors), dia 75 mm	9 228 344	Set	1	1,378
14		HCK 02 AB: One side Key and one side knob (For Room Doors), with 3 keys, dia 75 mm	9 228 345	Set	1	1,484
15		HCK 02 AB WC: One side Knob and other side emergency release slot, without key (for bathroom doors), dia 75 mm	9 228 346	Set	1	1,407

SS: Stainless Steel finish

PB: Polished Brass finish

AB: Antique Brass finish



## Cylindrical Handle Locks



Technical details:

- ▶ Suitable door thickness: 35mm – 45 mm
- ▶ Backset: 60 mm / 70 mm adjustable
- ▶ Function: Entrance /bathroom
- ▶ Material: Stainless steel / Zinc Alloy
- ▶ Version: Cylinder with 5 pins
- ▶ Finish: Stainless Steel / Polished Brass/Antique Brass

S.no.	Product Image	Description	Article No.	Unit	PU	MRP
1		HCH 01 SS: One side Key and one side knob (For Room Doors), with 3 keys, dia 75 mm	9 228 347	Set	1	1,683
2		HCH 01 SS WC: One side Knob and other side emergency release slot, without key (for bathroom doors), dia 75 mm	9 228 348	Set	1	1,607
3		HCH 01 PB: One side Key and one side knob (For Room Doors), with 3 keys, dia 75 mm	9 228 349	Set	1	1,989
4		HCH 01 PB WC: One side Knob and other side emergency release slot, without key (for bathroom doors), dia 75 mm	9 228 350	Set	1	1,912
5		HCH 01 AB: One side Key and one side knob (For Room Doors), with 3 keys, dia 75 mm	9 228 351	Set	1	1,989
6		HCH 01 AB WC: One side Knob and other side emergency release slot, without key (for bathroom doors), dia 75 mm	9 228 352	Set	1	1,912
7		HCH 02 SS: One side Key and one side knob (For Room Doors), with 3 keys, dia 65 mm	9 228 353	Set	1	1,958
8		HCH 02 SS WC: One side Knob and other side emergency release slot, without key (for bathroom doors), dia 65 mm	9 228 354	Set	1	1,882
9		HCH 02 PB: One side Key and one side knob (For Room Doors), with 3 keys, dia 65 mm	9 228 355	Set	1	2,263
10		HCH 02 PB WC: One side Knob and other side emergency release slot, without key (for bathroom doors), dia 65 mm	9 228 356	Set	1	2,188
11		HCH 02 AB: One side Key and one side knob (For Room Doors), with 3 keys, dia 65 mm	9 228 357	Set	1	2,263
12		HCH 02 AB WC: One side Knob and other side emergency release slot, without key (for bathroom doors), dia 65 mm	9 228 358	Set	1	2,188

SS: Stainless Steel finish      PB: Polished Brass finish      AB: Antique Brass finish







A Hettich & Poddar JV

*Hardware for Professionals*

**Contact Us**

Ahmedabad	+91 73044 07551
Bangalore	+91 73381 83871
Bhubaneshwar	+91 86574 21935
Hissar	+91 86575 23987
Hyderabad	+91 93951 42228
Jaipur	+91 86575 12894
Kanpur	+91 86575 14175
Kolkata	+91 82918 23966
Lucknow	+91 73044 07552
Ludhiana	+91 91360 16414
Meerut	+91 79050 00731
Mumbai	+91 82918 87129
New Delhi	+91 86575 58627
Patna	+91 86575 05171
Pune	+91 91520 10580

**Registered Office:**

Hepo India Private Limited  
A-26/4, 1st floor,  
Mohan Co-operative Industrial Estate,  
New Delhi - 110 044  
Phone: +91 11 4889 4000, 4889 4005  
Fax: +91 11 4889 4044

**Head Office:**

Hepo India Private Limited  
402, 4th floor, Durolite House,  
Opp. SAB TV, New Link Road,  
Andheri (West), Mumbai - 400 053  
Phone: +91 22 2674 3289/3356/4089  
Fax: +91 22 2674 3267

**Enquiry & Customer Services**

Toll Free : 1800 209 2096 (office hours)  
customer\_services@hepoindia.com  
www.hepoindia.com

