



Dekorative Möbelbeschläge
Bau- und Fachmarkt-Sortiment

Decorative furniture fittings
Retail assortment

Ferrures de meuble décoratives
Gamme de bricolage

Technik für Möbel

Hettich

Modern	013 - 020
<i>Antik & Retro</i>	021 - 030
Country	031 - 042
Classic	043 - 052
Colours & Kids	053 - 060
BUDGET	061 - 068

Modern	073 - 084
<i>Antik & Retro</i>	085 - 090
Country	091 - 096
Classic	097 - 106
Colours & Kids	107 - 110
BUDGET	111 - 116
Auslaufartikel Discontinued items Fin de série	117 - 122
Artikelnummernverzeichnis Order number index Références des articles / cadre technique	123 - 125

Verpackungsarten

Packaging types

Types d'emballage



Aufhängelasche
Hanger
Patte d'accrochage



Blisterbox
Blister box
Boîte blister



Lose
Loose
En vrac



Pappkarte
Card
Plaque en carton



Polybeutel mit Etikett
Polythene bag with label
Sachet en polyéthylène avec étiquette



Polybeutel mit Eurolochung
Polythene bag with Euro hole
Sachet en polyéthylène avec perforation européenne



Polybeutel mit Pappreiter
Polythene bag with header card
Sachet en polyéthylène avec carte à accrocher

Piktogramme

Pictograms

Pictogrammes



Höhe
Height
Hautuer



Breite
Width
Largeur



Länge / Tiefe
Length / depth
Longueur / profondeur



Durchmesser außen
External diameter
Diamètre extérieur



Durchmesser innen
Internal diameter
Diamètre intérieur



Lochabstand
Hole spacing
Ecartement entraxes



Auflagefläche
Support area
Surface d'appui



Türstärke Glas
Glass door thickness
Épaisseur de porte en verre



Unterbaumontage
Base frame mounting
Montage sous châssis



zum Aufschrauben
Screw-on
À visser



Massiv Messing
Pure brass
Laiton pur



Edelstahl rostfrei
Stainless steel
Acier inoxydable

Ihr Ansprechpartner / *your contact* / *votre contact*:

Hettich Do-It-Yourself GmbH & Co. KG

Lange Str. 51

49326 Melle-Neuenkirchen

Deutschland

Tel. +49 5428 92777-0

Fax +49 5428 92777-99

info@hettich-diy.com

www.hettich-diy.com

Familienunternehmen Hettich

Hettich, the family owned company
Hettich, une entreprise familiale



Die Geschichte von Hettich ist geprägt von herausragenden Ingenieurleistungen und mutigem Unternehmertum. Mit einer selbst entwickelten und eigens konstruierten Maschine mechanisierte Karl Hettich im Jahr 1888 die Produktion von Ankerhaken für Schwarzwälder Kuckucksuhren. Als August Hettich 1928 eine Fertigungsstraße für Stangenscharniere entwickelt hatte, betrat er technisches Neuland und stellte die Weichen für den heutigen Tätigkeitsbereich der Unternehmensgruppe in der Möbelindustrie. Mit viel Mut zum Risiko gründeten die Brüder Paul, August und Franz Hettich 1930 in Herford eine neue Gesellschaft. Mit dem Umzug nach Ostwestfalen-Lippe waren die Schwaben im Herzen der deutschen Möbelindustrie angekommen. Seit über 100 Jahren entwickeln und produzieren wir Technik für Möbel.

Die Unternehmensgruppe ist zu 100 Prozent in Familienbesitz und mit Dr. Andreas Hettich ist im Jahr 2005 die vierte Generation in die Geschäftsleitung eingezogen.

Hettich's history is defined by outstanding engineering achievements and bold enterprising decisions. Developing a purpose built machine, Karl Hettich in 1888 mechanised the production of anchor escapements for Black Forest cuckoo clocks. When August Hettich developed a production line for piano hinges in 1928, he was treading new technical terrain, setting the course for the group's present activities in the furniture industry. Taking a tremendous gamble in 1930, Paul, August and Franz Hettich set up a new company in Herford. The move to East Westphalia-Lippe took the Swabian brothers to the heart of the German furniture industry. We have been developing and producing technology for furniture for over 100 years.

The Hettich Group is entirely family owned, with Dr. Andreas Hettich taking the management into its fourth generation in 2005.

L'histoire de Hettich est marquée par des prestations d'ingénierie remarquables et un esprit d'entreprise teinté de bravoure. Avec une machine qu'il a lui-même développée et conçue, Karl Hettich mécanise, en 1888, la production de crochets d'ancrage pour horloges à coucou de la Forêt Noire. Lorsqu'il développe, en 1928, une chaîne de production pour charnières piano, August Hettich s'engage dans de nouvelles voies sur le plan technique et pose les jalons du domaine d'activité actuel du groupe dans l'industrie du meuble. Avec beaucoup de courage et de goût du risque, les frères Paul, August et Franz Hettich fondent, en 1930, une nouvelle société à Herford. En déménageant pour la Westphalie orientale-Lippe, les Souabes sont arrivés au cœur de l'industrie du meuble allemande. Depuis plus de 100 ans, nous développons et produisons de la quincaillerie pour ameublement (Technik für Möbel).

Le groupe est détenu à 100 % par la famille et, en la personne d'Andreas Hettich, c'est, en 2005, la quatrième génération qui a accédé à la direction.



Die Marke Hettich steht weltweit für Qualität, Innovation, Zuverlässigkeit und Kundennähe. Technik für Möbel – das ist unsere Leidenschaft. Mit unseren Beschlaglösungen begeistern wir Menschen rund um den Globus.

Tag für Tag stellen sich mehr als 6.000 Mitarbeiterinnen und Mitarbeiter der Herausforderung, intelligente Technik für Möbel zu entwickeln. Die Heimat des Familienunternehmens Hettich ist Kirchlegern, Deutschland. Hier entstehen Ideen für Möbelbeschläge, mit denen wir die Gegenwart und die Zukunft gestalten.

Im Baumarkt können wir deshalb mit Herstellerkompetenz überzeugen und dem Heimwerker Innovationen und Qualität liefern.

The Hettich brand is synonymous with quality, innovation, reliability and customer focus the world over. Technology for furniture – that's our passion. Our fitting solutions excite people across the globe.

Every day, over 6,000 members of staff take up the challenge of developing intelligent technology for furniture. A family owned business, Hettich is at home in Kirchlegern, Germany. This is where ideas are born for furniture fittings we shape today and tomorrow with.

This means we can impress with production expertise in the DIY store and give the DIYer innovative products and quality.

Dans le monde entier, la marque Hettich est synonyme de qualité, d'innovation, de fiabilité et de proximité client. Technik für Möbel – telle est notre passion. Avec nos solutions de ferrures, nous suscitons l'enthousiasme d'hommes et de femmes dans le monde entier.

Chaque jour, quelque 6 000 collaboratrices et collaborateurs relèvent le défi consistant à développer de la quincaillerie intelligente pour l'ameublement. Le berceau de l'entreprise familiale est situé à Kirchlegern, en Allemagne. C'est là que voient le jour des idées de ferrures de meubles par lesquelles nous concevons le présent et l'avenir.

Dans le magasin de bricolage, nous pouvons ainsi convaincre les clients par notre compétence de fabricant et offrir aux bricoleurs toutes nos innovations et la qualité exceptionnelle des produits et services Hettich.

Kompetenz zum Mitnehmen: Hettich eService
Expertise to take with you: Hettich eService
Compétence à emporter : Hettich eService



Hettich eService

Auf die bewährten und verlässlichen Online-Tools müssen Sie nirgendwo verzichten. Stets aktuell und verfügbar – Onlinekatalog, Mediathek, Social Media. Sämtliche Tools erreichen Sie ganz einfach über unsere Website

www.hettich-diy.com

Hettich eService

There's no need to go without the proven and reliable online tools anywhere either. Always up to date and available – online catalogue, media library, social media. You can get all tools very easily from our website

www.hettich-diy.com

Hettich eService

N'hésitez pas à utiliser les outils en ligne fiables et éprouvés de Hettich. Toujours actuels et disponibles – le catalogue en ligne, la médiathèque et les réseaux sociaux. Vous accédez facilement à tous les outils par notre site Internet

www.hettich-diy.com

Hettich App

Ob aktuelle Kataloge, Magazine, Anleitungen oder Videos – jetzt noch einfacher und schneller. Einfach die Hettich App im App Store oder im Google Play Store herunterladen, sagen wer Sie sind und wir stellen Ihnen die passenden Informationen zur Verfügung.



Hettich App

Whether it's the latest catalogues, magazines, instructions or videos you want – you can now get them even easier and faster. Simply download the Hettich App from the App Store or from the Google Play Store, say who you are and we'll provide you with the information you need.



L'appli Hettich

Que ce soient les catalogues actuels, les magazines, les notices ou les vidéos – maintenant, c'est encore plus simple et plus rapide. Télécharger tout simplement l'appli Hettich dans App Store ou Google Play Store, dites qui vous êtes et nous mettrons à votre disposition les informations nécessaires.

Verpackungsarten
Packaging types
Types d'emballage

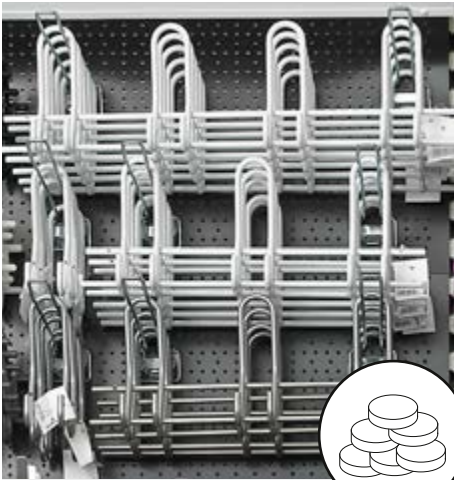

Unverpackte Ware
Non packaged products
Produit non emballé



Polybeutel mit Etikett
Polythene bag with label
Sachet en polyéthylène avec étiquette

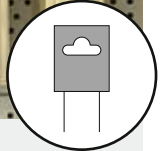

Ware mit Aufhängelasche
Products with hanger
Produit avec patte d'accrochage

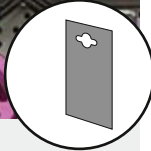

Pappkarte
Card
Plaque en carton



Blisterbox mit Euroloch und Einleger
Blister box with Euro hole and insert
Boîte blister avec perforation européenne et insert



Polybeutel mit Eurolochung
Polythene bag with Euro hole
Sachet en polyéthylène avec perforation européenne



Trends verändern die Welt. Sie entstehen durch den stetigen gesellschaftlichen und technologischen Wandel. Menschen nutzen Trends um sich auszudrücken: ihre Persönlichkeit, Einstellungen, Träume und Emotionen. Das eigene Zuhause ist dabei der wichtigste Ort, an dem das persönliche Lebensgefühl zum Ausdruck kommt. Mit Mustern, Formen, Farben und Materialien wird der eigene Wohnraum kreiert.

Dekorative Beschläge spielen als Gestaltungselement in Räumen eine wichtige Rolle. Mit wenig Aufwand lässt sich beispielsweise mit einem Griff ein Trend auf jedes Möbel übertragen und eine starke Wirkung erzielen. Dazu muss ein Griff einen Trend zum fühlbaren Erlebnis machen. Design, Material und Haptik müssen unverwechselbar sein. Der Griff ist das, was man zuerst berührt, der erste Kontakt mit dem Möbel.

Konsequent marktorientiert ermöglichen die dekorativen Beschläge von Hettich die trendorientierte Individualisierung von Möbeln. Entdecken Sie die Trendwelten – und die vielen neuen Ideen für Ihre Küche und Möbel.

Trends reshape the world. They are born out of the constant changes in society and technology. People use trends to express themselves: their personality, attitudes, dreams and emotions. This is where the home they live in is the most important place that reflects their approach to life. Their living space is created by patterns, shapes, colours and materials.

As a design element, decorative fittings play an important part in a room. With little effort, for example, a handle can be used to take a trend to any piece of furniture and provide a powerful impact. To do this, a handle must make a trend a tangible experience. Design, material and feel must be unmistakable. The handle is the first part you touch, the first contact with furniture."

Resolutely focusing on the market, decorative fittings from Hettich provide the key to individualising furniture in line with prevailing trends. Discover the trend styles – and the many new ideas for your kitchen and furniture.

Les tendances changent le monde. Elles sont le fruit de la constante mutation sociale et technologique. L'être humain se sert des tendances pour exprimer sa personnalité, ses conceptions des choses, ses rêves et ses émotions. Le chez-soi est le lieu principal d'expression de l'attitude personnelle par rapport à la vie. Avec des motifs, des formes, des couleurs et des matériaux, on crée son propre espace de vie.

Les ferrures décoratives jouent, en tant qu'élément d'aménagement, un rôle important dans les pièces. À peu de frais, on peut, par exemple, avec une poignée, appliquer une tendance à chaque meuble et obtenir un effet majeur. Pour ce faire, une poignée doit transformer une tendance en expérience palpable. Le design, le matériau et le toucher doivent être uniques. La poignée, c'est ce qu'on touche en premier, le premier contact avec le meuble.

Les ferrures décoratives de Hettich systématiquement orientées vers le marché facilitent l'identification de l'acheteur de meubles avec son propre style tout comme l'individualisation orientée tendance des meubles. Découvrez les univers tendance – et les diverses nouvelles idées pour votre cuisine et vos meubles.

TREND - BACK TO...

... Fifties, Sixties and Eighties. Sanfte Pastelltöne treffen kräftige Farbtupfer. Dynamische Rundungen trotzen schnurgeraden Linien. Die freche Designphilosophie der 1950er und 1960er Jahre erlebt bei Möbeln und Accessoires eine fulminante Renaissance. Mit unserer Kollektion setzen Sie diesen Wohntrend überzeugend um – auch in Kombination mit anderen Einrichtungsstilen.



TREND - BACK TO...

... Fifties, Sixties and Eighties. Soft pastel shades meet splashes of vibrant colour. Dynamically rounded contours defy dead straight lines. The daring design philosophy of the 1950s and 1960s is experiencing a spectacular comeback in furniture and accessories. Our collection lets you capture this home design trend with convincing authenticity – also in combination with other furnishing styles.



TREND - BACK TO...

... Fifties, Sixties and Eighties. Les tons pastel se marient avec des touches de couleur vive. Les rondeurs dynamiques bravent les lignes droites. La philosophie coquine du design des années 50 et 60 connaît une période de renaissance fulgurante dans le domaine des meubles et des accessoires. Notre collection permet de concrétiser avec persuasion cette tendance pour l'habitat même combinée avec d'autres styles de décoration.





TREND - VINTAGE

Alte Möbelstücke oder Möbel im Used-Look suggerieren das Gefühl von Geborgenheit und lassen Erinnerungen an vergangene Zeiten aufleben. Unsere aktuelle Kollektion harmoniert optimal mit diesem Einrichtungsstil.



TREND - VINTAGE

Old pieces of furniture or used look furniture suggest a sense of homeliness and rekindle memories of bygone times. Our latest collection harmonises perfectly with this furnishing style.



TREND - VINTAGE

Des éléments de mobilier ou des meubles anciens à l'aspect vieilli donnent un sentiment de sécurité et permettent de faire revivre les souvenirs des temps passés. Notre collection actuelle harmonise de manière optimale avec ce style de décoration.



Griffe & Knöpfe
Handles & knobs
Poignées et boutons

Unser Verkaufsregal: Griffe & Knöpfe
Our retail display: handles & knobs
Notre rayon: poignées et boutons



Die Warenpräsentation in Holzschubkästen ermöglicht die Warenbevorratung sowie die Demonstration der Artikel am Verkaufsregal.

Presenting merchandise in wooden drawer provides a place to keep stock and lets you demonstrate items in the retail display.

La présentation des articles dans des tiroirs en bois permet de stocker les produits et de montrer les articles dans les rayons des magasins.

Erklärung zu Maßangaben
 Explanation of the dimensions given
 Explication des dimensions

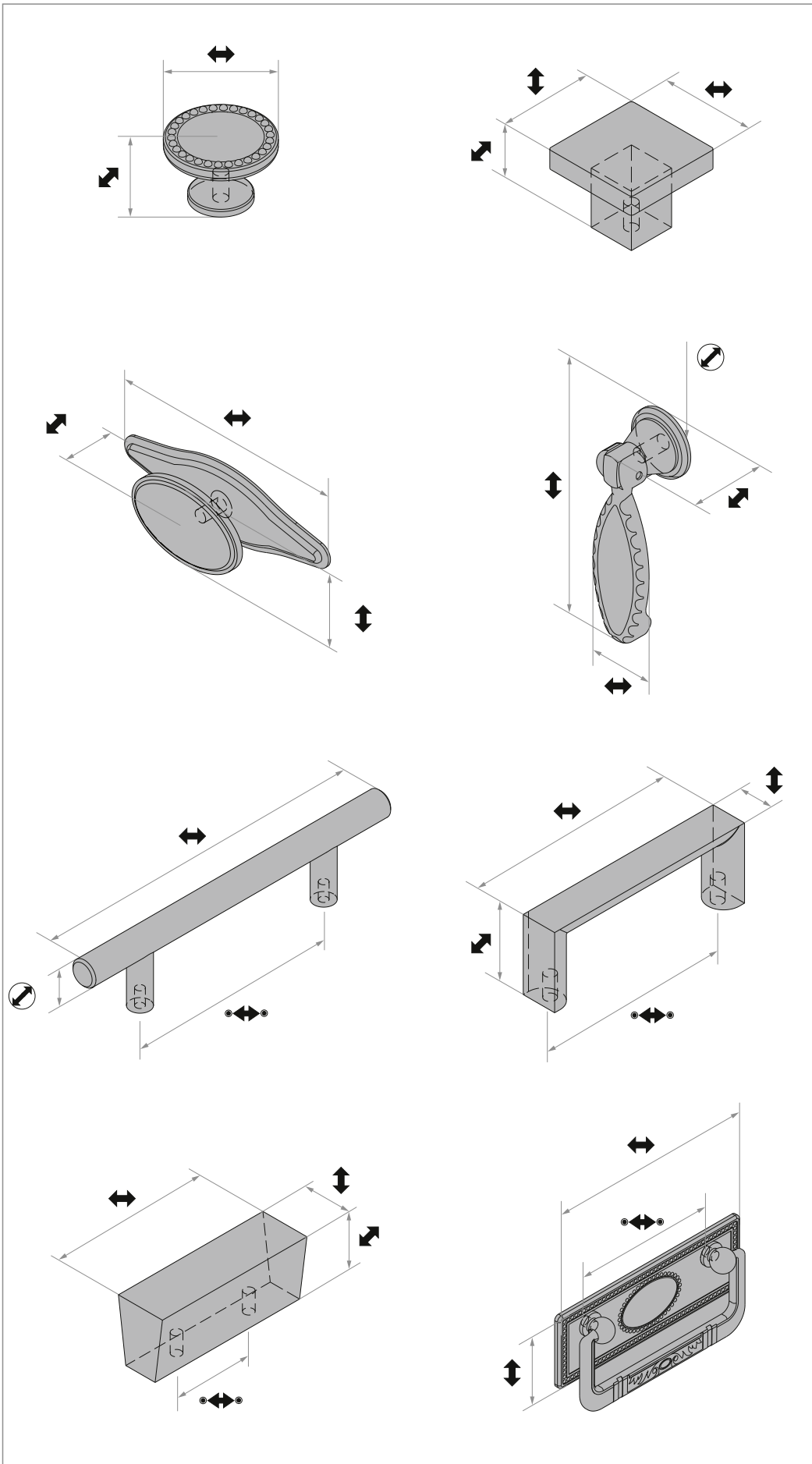

- 
 Lochabstand
 Hole spacing
 Ecartement entraxes

- 
 Höhe
 Height
 Hauteur

- 
 Breite
 Width
 Largeur

- 
 Länge / Tiefe
 Length / depth
 Longueur / profondeur

- 
 Durchmesser außen
 External diameter
 Diamètre extérieur

Berechnungsformeln
 Calculations formulae
 Formules de calcul

Seiten-Positionierung für einen Griff
 Side-positioning for a handle
 Positionnement pour une poignée

$$= \frac{\begin{array}{c} \text{Blendenbreite} \\ \text{Fascia panel width} \\ \text{Largeur de façade} \end{array} - \begin{array}{c} \text{Bohrabstand} \\ \text{Hole distance} \\ \text{Distance de perçage} \end{array}}{2}$$

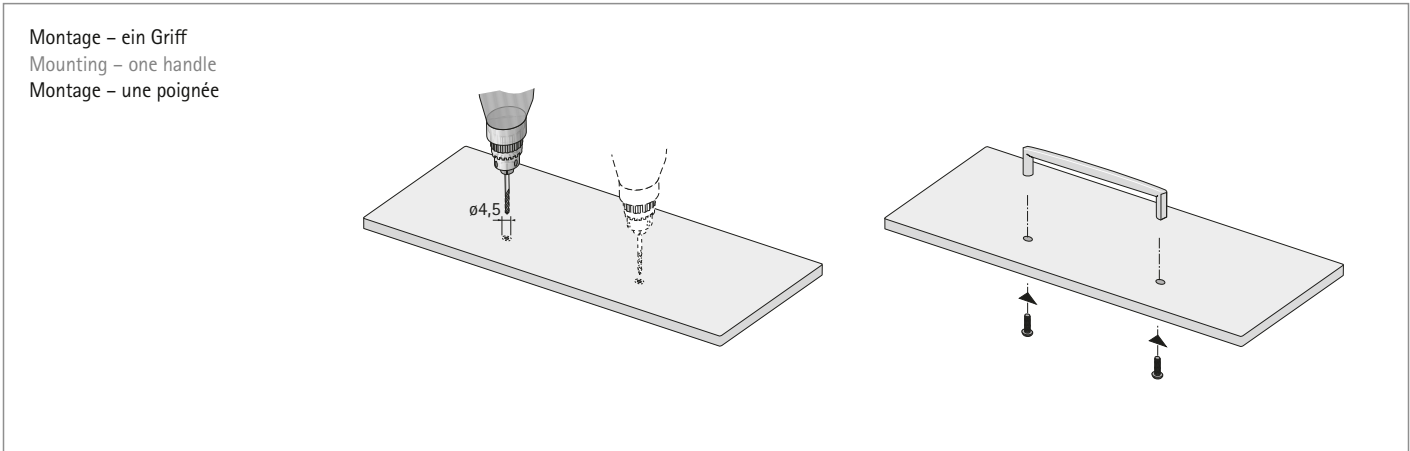

Seiten-Positionierung für einen Knopf
 Side-positioning for a knob
 Positionnement pour un bouton

$$= \frac{\text{Blendenbreite} \\ \text{Fascia panel width} \\ \text{Largeur de façade}}{2}$$

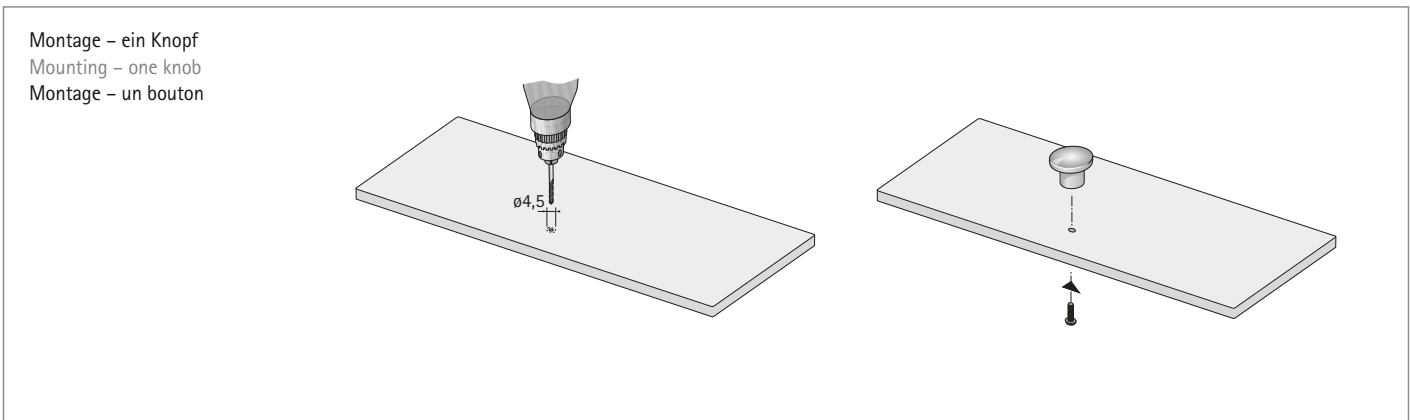

Modern

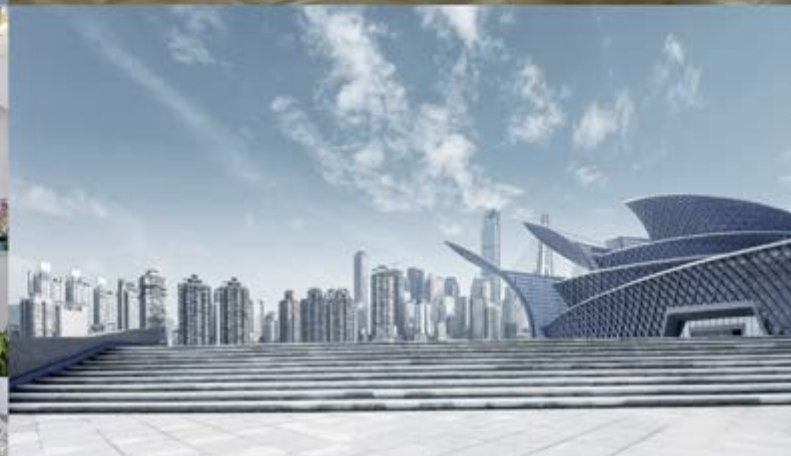

Technik, Transparenz und sachliche Strukturen bestimmen das moderne Leben und Wohnen. Futuristisches Design und eine klare, reduzierte Formgebung machen die Griffe MODERN unverwechselbar. Die Form folgt dabei den technischen Möglichkeiten ihrer Herstellung und setzt reizvolle optische Akzente.

Technology, transparency and linear structures define modern life and the home environment. Futuristic design and a clear-cut, reduced style make the MODERN handles unmistakable. Their shape results from the technical means of producing them and creates a visual fascination.

La technique, la transparence et les structures neutres caractérisent la vie et l'habitat modernes. Un design futuriste et des formes réduites très claires rendent les poignées MODERN uniques au monde. La forme épouse les possibilités techniques de sa fabrication et crée des accents optiques charmants.



Möbelgriff
▶ Zinkdruckguss

1 Schwarz verchromt
Black chrome-plated
Chromé noir

2 Edelstahl-Optik
Stainless steel look
Aspect acier affiné

3 Verchromt
Chrome-plated
Chromé

4 Aluminium-Optik
Aluminium look
Aspect aluminium



Furniture handle
▶ Zinc die-cast

Furniture handle
▶ Zinc die-cast

Nr./No./Ref.	EAN	↔ mm	↔ mm	↕ mm	↗ mm	VE/PU/Qte
1 9 196 999	40080571066259	128	137,5	12	26,5	1
2 0 003 436	40080571034364	64	72,5	12	26,5	1
2 0 007 617	40080571076173	128	137,5	12	26,5	1
3 9 202 432	40080571066914	96	104	12	26,5	1
3 0 007 616	40080571076166	128	137,5	12	26,5	1
4 9 196 996	40080571066204	128	137,5	12	26,5	1



Möbelgriff
▶ Zinkdruckguss

Edelstahl-Optik
Stainless steel look
Aspect acier affiné

Furniture handle
▶ Zinc die-cast

Poignée de meuble
▶ Zamak

Nr./No./Ref.	EAN	↔ mm	↔ mm	↕ mm	↗ mm	VE/PU/Qte
9 196 506	40080571065764	96	104	7,5	28	1
9 196 507	40080571065771	128	135	7,5	28	1
9 196 508	40080571065788	160	166	7,5	28	1



Möbelgriff
▶ Edelstahl

Gebürstet
Brushed
Brossé



Furniture handle
▶ Stainless steel

Poignée de meuble
▶ Acier affiné

Nr./No./Ref.	EAN	↔ mm	↔ mm	↕ mm	↗ mm	VE/PU/Qte
9 207 900	40080571907330	96	111	14	40	1
9 162 886	40080571023269	128	142	14	40	1
9 162 887	40080571023276	160	174	14	40	1
9 207 895	40080571907286	224	238	14	40	1
9 207 896	40080571907293	320	334	14	40	1



Möbelgriff
▶ Zinkdruckguss

1 Aluminium-Optik
Aluminium look
Aspect aluminium

2 Edelstahl-Optik
Stainless steel look
Aspect acier affiné



Furniture handle
▶ Zinc die-cast

Poignée de meuble
▶ Zamak

Nr./No./Ref.	EAN	↔ mm	↔ mm	↕ mm	↗ mm	VE/PU/Qte
1 9 207 834	40080571906678	96	130	9	28	1
2 9 207 833	40080571906661	96	130	9	28	1



Möbelgriff
▶ Zinkdruckguss

Furniture handle
▶ Zinc die-cast

Poignée de meuble
▶ Zamak

Edelstahl-Optik
Stainless steel look
Aspect acier affiné

Nr./No./Ref.	EAN	↔ mm	↔ mm	↕ mm	↗ mm	VE/PU/Qte
9 207 899	40080571907323	128	157	20	22,5	1
9 207 898	40080571907316	160	192	22	25,5	1
9 207 897	40080571907309	192	226	25	25,5	1



Möbelgriff
▶ Zinkdruckguss

Furniture handle
▶ Zinc die-cast

Poignée de meuble
▶ Zamak

1 Verchromt
Chrome-plated
Chromé

2 Aluminium-Optik
Aluminium look
Aspect aluminium

3 Edelstahl-Optik
Stainless steel look
Aspect acier affiné



Nr./No./Ref.	EAN	↔ mm	↔ mm	↕ mm	↗ mm	VE/PU/Qte
1 9 196 391	40080571063913	96	106,5	11	23,5	1
1 9 196 390	40080571063906	128	138,5	11	23,5	1
2 9 196 414	40080571065542	96	106,5	11	23,5	1
2 9 196 396	40080571063975	128	138,5	11	23,5	1
3 9 196 394	40080571063944	96	106,5	11	23,5	1
3 9 196 393	40080571063937	128	138,5	11	23,5	1



Möbelgriff
▶ Stahl

Furniture handle
▶ Steel

Poignée de meuble
▶ Acier

Edelstahl-Optik
Stainless steel look
Aspect acier affiné

Nr./No./Ref.	EAN	↔ mm	↔ mm	↕ mm	↗ mm	VE/PU/Qte
0 007 621	40080571076210	128	145,5	17,5	25	1



Möbelgriff
▶ Zinkdruckguss

Furniture handle
▶ Zinc die-cast

Poignée de meuble
▶ Zamak

1 Aluminium-Optik
Aluminium look
Aspect aluminium

2 Edelstahl-Optik
Stainless steel look
Aspect acier affiné



Nr./No./Ref.	EAN	↔ mm	↔ mm	↕ mm	↗ mm	VE/PU/Qte
1 9 207 841	40080571906746	96	109	13,5	25	1
1 9 207 849	40080571906821	128	140,5	13,5	26,5	1
2 9 207 835	40080571906685	96	109	13,5	25	1
2 9 207 840	40080571906739	128	140,5	13,5	26,5	1



Möbelgriff
▶ Zinkdruckguss

Furniture handle
▶ Zinc die-cast

Poignée de meuble
▶ Zamak

Vernickelt
Nickel plated
Nickelé

Nr./No./Ref.	EAN	↔ mm	↔ mm	↕ mm	↗ mm	VE/PU/Qte
9 207 877	40080571907101	96	114	14,5	25	1



Möbelgriff
▶ Aluminium

1 Edelstahl-Optik
Stainless steel look
Aspect acier affiné

2 Aluminium-Optik
Aluminium look
Aspect aluminium



Furniture handle
▶ Aluminium

Poignée de meuble
▶ Aluminium

Nr./No./Ref.	EAN	↔ mm	↔ mm	↕ mm	↗ mm	VE/PU/Qte
1 9 196 415	4008057065559	32	47	13	15	1
1 9 196 392	4008057063920	64	80	13	15	1
1 9 196 395	4008057063968	96	112	13	15	1
1 9 196 400	4008057029582	128	144	13	15	1
1 9 196 389	4008057065597	160	175	13	15	1
2 9 211 884	4008057035286	32	47	13	15	1
2 9 211 885	4008057035293	64	80	13	15	1
2 9 211 886	4008057035309	96	112	13	15	1



Möbelgriff
▶ Aluminium

Edelstahl-Optik
Stainless steel look
Aspect acier affiné

Furniture handle
▶ Aluminium

Poignée de meuble
▶ Aluminium

Nr./No./Ref.	EAN	↔ mm	↔ mm	↕ mm	↗ mm	VE/PU/Qte
9 202 458	4008057067010	60	80	12,5	35	1
9 202 459	4008057067027	80	100	12,5	35	1
9 202 457	4008057066976	160	180	12,5	35	1
9 202 460	4008057067034	260	280	12,5	35	1



Möbelgriff
▶ Aluminium

Eloxiert
Anodised
Anodisé

Furniture handle
▶ Aluminium

Poignée de meuble
▶ Aluminium

Nr./No./Ref.	EAN	↔ mm	↔ mm	↕ mm	↗ mm	VE/PU/Qte
9 207 892	4008057907255	32	45	23	24	1
9 207 893	4008057907262	96	120	23	24	1
9 207 894	4008057907279	128	150	23	24	1



Möbelgriff
▶ Aluminium

1 Aluminium-Optik
Aluminium look
Aspect aluminium

2 Edelstahl-Optik
Stainless steel look
Aspect acier affiné

3 Verchromt
Chrome-plated
Chromé



Furniture handle
▶ Aluminium

Poignée de meuble
▶ Aluminium

Nr./No./Ref.	EAN	↔ mm	↔ mm	↕ mm	↗ mm	VE/PU/Qte
1 9 196 397	4008057063982	128	146	7,8	32	1
1 9 196 416	4008057065566	160	177	7,8	32	1
2 9 196 412	4008057065528	128	146	7,8	32	1
2 9 196 413	4008057065535	160	177	7,8	32	1
3 9 196 411	4008057065511	128	146	7,8	32	1

Möbelgriff
▶ Aluminium



1 Kupfer-Optik, brüniert
Copper look, burnished
Aspect cuivre, bruni











2 Vermessingt, brüniert
Brass-plated, burnished
Laitonné, bruni



3 Aluminium-Optik
Aluminium look
Aspect aluminium

Furniture handle
▶ Aluminium

Poignée de meuble
▶ Aluminium

Nr./No./Ref.	EAN	↔ mm	↔ mm	↕ mm	↗ mm	VE/PU/Qte
1 9 196 994	40080571066174	32	46	10	23	1 
1 9 199 022	40080571030182	64	78	10	23	1 
1 9 184 215	40080571024976	96	110	10	23	1 
2 9 196 995	40080571066181	32	46	10	23	1 
2 9 199 023	40080571030311	64	78	10	23	1 
2 9 184 221	40080571024983	96	110	10	23	1 
3 9 196 997	40080571066211	32	46	10	23	1 
3 9 196 998	40080571066228	96	110	10	23	1 
3 9 184 704	40080571026222	128	160	8,7	17	1 





Möbelgriff
▶ Aluminium



Eloxiert / verchromt
Anodised / chrome-plated
Anodisé / chromé

Furniture handle
▶ Aluminium

Poignée de meuble
▶ Aluminium

Nr./No./Ref.	EAN	↔ mm	↔ mm	↕ mm	↗ mm	VE/PU/Qte
9 208 473	40080571920230	32	45	9	17	1 
9 208 474	40080571920247	64	90	9	17	1 
9 209 266	40080571032933	96	120	9	17	1 
9 208 475	40080571920254	128	150	9	17	1 

Möbelgriff
▶ Zinkdruckguss





1 Vernickelt
Nickel-plated
Nickelé



2 Aluminium-Optik
Aluminium look
Aspect aluminium

Furniture handle
▶ Zinc die-cast

Poignée de meuble
▶ Zamak

Nr./No./Ref.	EAN	↔ mm	↔ mm	↕ mm	↗ mm	VE/PU/Qte
1 9 207 842	40080571906753	32	42,5	10,5	27	1 
2 9 207 839	40080571906722	32	42,5	10,5	27	1 

Möbelgriff
▶ Zinkdruckguss



Verchromt
Chrome-plated
Chromé

Furniture handle
▶ Zinc die-cast

Poignée de meuble
▶ Zamak

Nr./No./Ref.	EAN	↔ mm	↔ mm	↕ mm	↗ mm	VE/PU/Qte
9 158 101	40080571019866	64	72	24	20	1 



Möbelgriff
▶ Aluminium

Furniture handle
▶ Aluminium

Poignée de meuble
▶ Aluminium

Eloxiert
Anodised
Anodisé

Nr./No./Ref.	EAN	↔ mm	↔ mm	↕ mm	↗ mm	VE/PU/Qte
9 207 891	40080571907248	96	104	16	35,5	1
9 207 888	40080571907217	128	136	16	35,5	1
9 207 889	40080571907224	160	168	16	35,5	1
9 207 890	40080571907231	192	200	16	35,5	1
9 150 617	40080571013604	224	232	16	35,5	1
9 153 521	40080571014700	256	264	16	35,5	1
9 150 561	40080571013581	320	328	16	35,5	1
9 180 267	40080571020466	532	540	16	35,5	1



Einlassgriff
▶ Bohrmaß 90 x 28 mm
▶ Edelstahl

Recessed handle
▶ Hole distance 90 x 28 mm
▶ Stainless steel

Poignée encastrée insert
▶ Dimensions de perçage 90 x 28 mm
▶ Acier affiné

Gebürstet
Brushed
Brossé



Nr./No./Ref.	EAN	↔ mm	↔ mm	↕ mm	↗ mm	VE/PU/Qte
9 102 511	40080571012690	110	120	40	12	1



Einlassgriff
▶ Edelstahl

Recessed handle
▶ Stainless steel

Poignée encastrée insert
▶ Acier affiné

Gebürstet
Brushed
Brossé



Nr./No./Ref.	EAN	↔ mm	↗ mm	↖ mm	↗ mm	VE/PU/Qte
9 102 512	40080571012706	80	21	90	70	1



Möbelgriff
▶ Zinkdruckguss

Furniture handle
▶ Zinc die-cast

Poignée de meuble
▶ Zamak

Edelstahl-Optik
Stainless steel look
Aspect acier affiné

Nr./No./Ref.	EAN	↔ mm	↔ mm	↕ mm	↗ mm	VE/PU/Qte
0 014 148	40080571141482	96	134,5	18	21	1



Möbelknopf
▶ Zinkdruckguss

Furniture knob
▶ Zinc die-cast

Bouton de meuble
▶ Zamak

Edelstahl-Optik
Stainless steel look
Aspect acier affiné

Nr./No./Ref.	EAN	↔ mm	↕ mm	↗ mm	VE/PU/Qte
0 015 980	40080571159807	18	18	19,5	1
0 015 984	40080571159843	24	24	21	1



Möbelknopf
▶ Zinkdruckguss

Furniture knob
▶ Zinc die-cast

Bouton de meuble
▶ Zamak

Edelstahl-Optik
Stainless steel look
Aspect acier affiné

Nr./No./Ref.	EAN	↔ mm	↕ mm	↗ mm	VE/PU/Qte
9 207 865	4008057069821	37,7	37,7	21	1



Möbelknopf
▶ Zinkdruckguss

Furniture knob
▶ Zinc die-cast

Bouton de meuble
▶ Zamak

1 Verchromt
Chrome-plated
Chromé

2 Edelstahl-Optik
Stainless steel look
Aspect acier affiné

3 Aluminium-Optik
Aluminium look
Aspect aluminium



Nr./No./Ref.	EAN	↔ mm	↕ mm	↗ mm	VE/PU/Qte
1 9 196 385	4008057065047	30	30	24,5	1
2 9 196 386	4008057065054	30	30	24,5	1
3 9 196 368	4008057063951	30	30	24,5	1



Möbelknopf
▶ Zinkdruckguss

Furniture knob
▶ Zinc die-cast

Bouton de meuble
▶ Zamak

Aluminium-Optik
Aluminium look
Aspect aluminium

Nr./No./Ref.	EAN	↔ mm	↕ mm	↗ mm	VE/PU/Qte
9 196 387	4008057065504	18	18	23	1

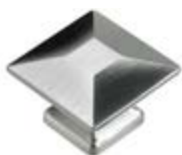

Möbelknopf
▶ Zinkdruckguss

Furniture knob
▶ Zinc die-cast

Bouton de meuble
▶ Zamak

1 Edelstahl-Optik
Stainless steel look
Aspect acier affiné

2 Aluminium-Optik
Aluminium look
Aspect aluminium

3 Verchromt
Chrome-plated
Chromé



Nr./No./Ref.	EAN	↔ mm	↕ mm	↗ mm	VE/PU/Qte
1 9 208 486	4008057920339	25	25	18	1
2 9 208 488	4008057920353	25	25	18	1
3 9 208 489	4008057920360	25	25	18	1



Möbelknopf
▶ Zinkdruckguss

Furniture knob
▶ Zinc die-cast

Bouton de meuble
▶ Zamak

Aluminium-Optik
Aluminium look
Aspect aluminium

Nr./No./Ref.	EAN	↔ mm	↕ mm	↗ mm	VE/PU/Qte
9 158 096	4008057019842	13	13	16	1



Möbelgriff
▶ Aluminium

Furniture handle
▶ Aluminium

Poignée de meuble
▶ Aluminium

1 Kupfer-Optik, brüniert
Copper look, burnished
Aspect cuivre, bruni

2 Silberfarben, brüniert
Silver coloured, burnished
Teinté argent, bruni

3 Edelstahl-Optik
Stainless steel look
Aspect acier affiné

4 Aluminium-Optik
Aluminium look
Aspect aluminium



Nr./No./Ref.	EAN	↔ mm	↔ mm	↕ mm	↗ mm	VE/PU/Qte
1 9 196 992	4008057066143	32	60	40	26	1
2 9 196 993	4008057066167	32	60	40	26	1
3 9 196 991	4008057066136	32	60	40	26	1
4 9 196 960	4008057066006	32	60	40	26	1



Möbelgriff
▶ Aluminium

Furniture handle
▶ Aluminium

Poignée de meuble
▶ Aluminium

1 Edelstahl-Optik
Stainless steel look
Aspect acier affiné

2 Aluminium-Optik
Aluminium look
Aspect aluminium

3 Silberfarben, brüniert
Silver coloured, burnished
Teinté argent, bruni

4 Kupfer-Optik, brüniert
Copper look, burnished
Aspect cuivre, bruni



Nr./No./Ref.	EAN	↔ mm	↔ mm	↕ mm	↗ mm	VE/PU/Qte
1 9 082 150	4008057020046	128	190	40	28	1
2 9 196 957	4008057066198	128	190	40	28	1
3 9 082 151	4008057020053	128	190	40	28	1
4 9 082 152	4008057020060	128	190	40	28	1



Möbelknopf
▶ Zinkdruckguss

Furniture knob
▶ Zinc die-cast

Bouton de meuble
▶ Zamak

1 Schwarz vernickelt
Black nickel-plated
Nickel noir

2 Edelstahl-Optik
Stainless steel look
Aspect acier affiné



Nr./No./Ref.	EAN	↗ mm	↘ mm	VE/PU/Qte
1 9 197 014	4008057066112	29	32	1
1 9 197 000	4008057066129	35	45	1
2 9 208 481	40080570920292	29	32	1
2 9 208 482	40080570920308	35	45	1



Antik & Retro



Beständigkeit vermittelt Geborgenheit. Traditionelle Formen und Farben sowie üppige Muster bereichern den Alltag der modernen Sachlichkeit. Das Design der Griff-Kollektion ANTIK & RETRO greift gekonnt den bunten Stil- und Materialmix des Retrostyles auf. Auffallend anders und ausdrucksstark in Form, Oberfläche und Material unterstreichen die Griffe im Wohnraum den individuellen Charakter seiner Bewohner.

Consistency conveys a sense of homely warmth and comfort. Traditional shapes and colours as well as opulent patterns enrich everyday routine in the world of modern practicality. The design of the ANTIQUE & RETRO handle collection skilfully picks up on the colourful combination of styles and materials in retro style. Strikingly different and expressive in shape, surface and material, these handles underscore the personal character of the home's inhabitants.

La constance suscite la sécurité. Des formes et des couleurs traditionnelles ainsi que des motifs exubérants enrichissent le quotidien de la sobriété moderne. Le design de la collection de poignées ANTIK et RETRO reprend l'alliance très colorée des styles et des matériaux du style rétro. Visiblement différentes et expressives de par la forme, la surface et le matériau, les poignées d'un logement soulignent le caractère individuel de ses habitants.



Möbelgriff
▶ Messing / Zinkdruckguss

Furniture handle
▶ Brass / Zinc die-cast

Poignée de meuble
▶ Laiton / zamak

1 Silberfarben, brüniert
Silver coloured, burnished
Teinté argent, bruni

2 Vermessingt, brüniert
Brass-plated, burnished
Laitonné, bruni



Nr./No./Ref.	EAN	↔ mm	↔ mm	↕ mm	↗ mm	VE/PU/Qte
1 9 193 798	4008057027571	64	96	33	14	1
2 9 157 280	4008057018555	64	96	33	14	1



Möbelgriff
▶ Messing / Zinkdruckguss

Furniture handle
▶ Brass / Zinc die-cast

Poignée de meuble
▶ Laiton / zamak

1 Vermessingt, brüniert
Brass-plated, burnished
Laitonné, bruni

2 Silberfarben, brüniert
Silver coloured, burnished
Teinté argent, bruni



Nr./No./Ref.	EAN	↔ mm	↔ mm	↕ mm	↗ mm	VE/PU/Qte
1 9 157 279	4008057018548	64	94	30	14	1
2 9 196 388	4008057065573	64	94	30	14	1



Möbelgriff
▶ Zinkdruckguss

Furniture handle
▶ Zinc die-cast

Poignée de meuble
▶ Zamak

1 Silberfarben, brüniert
Silver coloured, burnished
Teinté argent, bruni

2 Vermessingt, brüniert
Brass-plated, burnished
Laitonné, bruni



Nr./No./Ref.	EAN	↔ mm	↔ mm	↕ mm	↗ mm	VE/PU/Qte
1 9 193 793	4008057027533	64	88	12	22	1
2 0 003 679	4008057036795	64	88	12	22	1



Möbelgriff
▶ Zinkdruckguss

Furniture handle
▶ Zinc die-cast

Poignée de meuble
▶ Zamak

1 Vermessingt, brüniert
Brass-plated, burnished
Laitonné, bruni

2 Silberfarben, brüniert
Silver coloured, burnished
Teinté argent, bruni



Nr./No./Ref.	EAN	↔ mm	↔ mm	↕ mm	↗ mm	VE/PU/Qte
1 9 157 278	4008057018531	64	82	33	22	1
2 9 196 399	4008057065023	64	82	33	22	1



Möbelgriff
▶ Zinkdruckguss

Furniture handle
▶ Zinc die-cast

Poignée de meuble
▶ Zamak

1 Silberfarben, brüniert
Silver coloured, burnished
Teinté argent, bruni

Nr./No./Ref.	EAN	↔ mm	↔ mm	↕ mm	↗ mm	VE/PU/Qte
1 9 193 795	4008057027540	64	85	30	15	1
2 9 196 398	4008057065016	64	85	30	15	1

2 Vermessingt, brüniert
Brass-plated, burnished
Laitonné, bruni



Möbelgriff
▶ Zinkdruckguss

Furniture handle
▶ Zinc die-cast

Poignée de meuble
▶ Zamak

Vermessingt, brüniert
Brass-plated, burnished
Laitonné, bruni

Nr./No./Ref.	EAN	↔ mm	↔ mm	↕ mm	↗ mm	VE/PU/Qte
9 196 514	4008057065917	96	120	45	19	1



Möbelknopf
▶ Messing / Zinkdruckguss

Furniture knob
▶ Brass / Zinc die-cast

Bouton de meuble
▶ Laiton / zamak

1 Vermessingt, brüniert
Brass-plated, burnished
Laitonné, bruni

Nr./No./Ref.	EAN	↔ mm	↕ mm	↗ mm	VE/PU/Qte
1 9 193 799	4008057027588	33	35	14	1
2 9 193 800	4008057027595	33	35	14	1

2 Silberfarben, brüniert
Silver coloured, burnished
Teinté argent, bruni



Möbelknopf
▶ Zinkdruckguss

Furniture knob
▶ Zinc die-cast

Bouton de meuble
▶ Zamak

1 Silberfarben, brüniert
Silver coloured, burnished
Teinté argent, bruni

Nr./No./Ref.	EAN	↗ mm	↘ mm	VE/PU/Qte
1 9 193 780	4008057027526	9	37	1
2 9 196 384	4008057065030	9	37	1

2 Vermessingt, brüniert
Brass-plated, burnished
Laitonné, bruni



Möbelknopf
▶ Zinkdruckguss

Furniture knob
▶ Zinc die-cast

Bouton de meuble
▶ Zamak

Vermessingt, brüniert
Brass-plated, burnished
Laitonné, bruni

Nr./No./Ref.	EAN	↔ mm	↕ mm	↗ mm	VE/PU/Qte
9 215 097	4008057037082	27	43	17	1



Möbelknopf
▶ Zinkdruckguss

Furniture knob
▶ Zinc die-cast

Bouton de meuble
▶ Zamak

Nr./No./Ref.	EAN	↔ mm	↕ mm	↗ mm	VE/PU/Qte
1 9 193 796	4008057027557	18,5	60	18	1
2 9 193 797	4008057027564	18,5	60	18	1

1 Vermessingt, brüniert
Brass-plated, burnished
Laitonné, bruni

2 Silberfarben, brüniert
Silver coloured, burnished
Teinté argent, bruni



Möbelknopf
▶ Zinkdruckguss

Furniture knob
▶ Zinc die-cast

Bouton de meuble
▶ Zamak

Nr./No./Ref.	EAN	↔ mm	↕ mm	↗ mm	VE/PU/Qte
9 196 367	4008057065580	17,5	70	17	1

Vermessingt, brüniert
Brass-plated, burnished
Laitonné, bruni



Möbelknopf
▶ Zinkdruckguss

Furniture knob
▶ Zinc die-cast

Bouton de meuble
▶ Zamak

Nr./No./Ref.	EAN	↗ mm	↖ mm	VE/PU/Qte
1 9 196 478	4008057065627	18	34	1
2 9 196 477	4008057065610	18	34	1

1 Silberfarben, brüniert
Silver coloured, burnished
Teinté argent, bruni

2 Vermessingt, brüniert
Brass-plated, burnished
Laitonné, bruni



Möbelknopf
▶ Zinkdruckguss

Furniture knob
▶ Zinc die-cast

Bouton de meuble
▶ Zamak

Nr./No./Ref.	EAN	↗ mm	↖ mm	VE/PU/Qte
9 197 005	4008057066020	17	36	1

Silberfarben, brüniert
Silver coloured, burnished
Teinté argent, bruni



Möbelknopf
▶ Zinkdruckguss

Furniture knob
▶ Zinc die-cast

Bouton de meuble
▶ Zamak

Nr./No./Ref.	EAN	↔ mm	↕ mm	↗ mm	VE/PU/Qte
1 9 193 779	4008057027519	77	26	20	1
2 9 196 369	4008057063999	77	26	20	1

1 Silberfarben, brüniert
Silver coloured, burnished
Teinté argent, bruni

2 Vermessingt, brüniert
Brass-plated, burnished
Laitonné, bruni





Möbelknopf
▶ Zinkdruckguss

Furniture knob
▶ Zinc die-cast

Bouton de meuble
▶ Zamak

Vermessingt, brüniert
Brass-plated, burnished
Laitonné, bruni

Nr./No./Ref.	EAN	↔ mm	↕ mm	↗ mm	VE/PU/Qte
9 211 882	4008057035279	35	21	28	1



Möbelknopf
▶ Zinkdruckguss

Furniture knob
▶ Zinc die-cast

Bouton de meuble
▶ Zamak

1 Kupfer-Optik, brüniert
Copper look, burnished
Aspect cuivre, bruni

2 Silberfarben, brüniert
Silver coloured, burnished
Teinté argent, bruni

3 Vermessingt, brüniert
Brass-plated, burnished
Laitonné, bruni

4 Brüniert
Burnished
Bruni



Nr./No./Ref.	EAN	↗ mm	↖ mm	VE/PU/Qte
1 9 202 464	4008057066938	20	25	1
1 9 197 013	4008057066105	25	32	1
2 9 202 463	4008057066921	20	25	1
2 9 202 461	4008057066846	25	32	1
3 9 197 008	4008057066051	20	25	1
3 9 208 471	40080570920216	25	32	1
4 9 197 006	4008057066037	20	25	1
4 9 202 462	4008057066990	25	32	1



Möbelknopf
▶ Zinkdruckguss

Furniture knob
▶ Zinc die-cast

Bouton de meuble
▶ Zamak

Vermessingt, brüniert
Brass-plated, burnished
Laitonné, bruni

Nr./No./Ref.	EAN	↗ mm	↖ mm	VE/PU/Qte
9 197 009	4008057066068	23	27	1



Möbelknopf
▶ Zinkdruckguss

Furniture knob
▶ Zinc die-cast

Bouton de meuble
▶ Zamak

Vermessingt, brüniert
Brass-plated, burnished
Laitonné, bruni

Nr./No./Ref.	EAN	↗ mm	↖ mm	VE/PU/Qte
9 197 010	4008057066075	26	32	1



Möbelknopf
▶ Zinkdruckguss

Furniture knob
▶ Zinc die-cast

Bouton de meuble
▶ Zamak

Vermessingt, brüniert
Brass-plated, burnished
Laitonné, bruni

Nr./No./Ref.	EAN	↗ mm	↖ mm	VE/PU/Qte
9 158 100	4008057019859	21,5	24	1



Möbelknopf
▶ Zinkdruckguss

Furniture knob
▶ Zinc die-cast

Bouton de meuble
▶ Zamak

Vermessingt, brüniert
Brass-plated, burnished
Laitonné, bruni

Nr./No./Ref.	EAN	mm	mm	VE/PU/Qte
9 161 863	40080571022392	24	25	1



Möbelknopf
▶ Zinkdruckguss

Furniture knob
▶ Zinc die-cast

Bouton de meuble
▶ Zamak

1 Silberfarben, brüniert
Silver coloured, burnished
Teinté argent, bruni

2 Vermessingt, brüniert
Brass-plated, burnished
Laitonné, bruni



Nr./No./Ref.	EAN	mm	mm	VE/PU/Qte
1 9 193 772	40080571027502	22	28	1
2 9 196 370	40080571065009	22	28	1



Möbelknopf
▶ Zinkdruckguss

Furniture knob
▶ Zinc die-cast

Bouton de meuble
▶ Zamak

Vermessingt, brüniert
Brass-plated, burnished
Laitonné, bruni

Nr./No./Ref.	EAN	mm	mm	VE/PU/Qte
9 196 479	40080571065641	18,5	26	1



Möbelknopf
▶ Zinkdruckguss

Furniture knob
▶ Zinc die-cast

Bouton de meuble
▶ Zamak

Vermessingt, brüniert
Brass-plated, burnished
Laitonné, bruni

Nr./No./Ref.	EAN	mm	mm	VE/PU/Qte
9 157 245	40080571018500	32	25	1



Möbelknopf
▶ Zinkdruckguss

Furniture knob
▶ Zinc die-cast

Bouton de meuble
▶ Zamak

Vermessingt, brüniert
Brass-plated, burnished
Laitonné, bruni

Nr./No./Ref.	EAN	mm	mm	mm	VE/PU/Qte
9 157 246	40080571018517	37	27	25,5	1



Möbelknopf
▶ Zinkdruckguss

Furniture knob
▶ Zinc die-cast

Bouton de meuble
▶ Zamak

Vermessingt, brüniert
Brass-plated, burnished
Laitonné, bruni

Nr./No./Ref.	EAN	mm	mm	VE/PU/Qte
9 215 098	40080571037112	21,5	25	1



Silberfarben, brüniert
Silver coloured, burnished
Teinté argent, bruni

Möbelknopf
▶ Zinkdruckguss

Furniture knob
▶ Zinc die-cast

Bouton de meuble
▶ Zamak

Nr./No./Ref.	EAN	↔ mm	↕ mm	↗ mm	VE/PU/Qte
9 197 001	4008057066150	45	45	27	1



Vermessingt, brüniert
Brass-plated, burnished
Laitonné, bruni

Möbelknopf
▶ Zinkdruckguss

Furniture knob
▶ Zinc die-cast

Bouton de meuble
▶ Zamak

Nr./No./Ref.	EAN	↔ mm	↕ mm	↗ mm	VE/PU/Qte
9 196 452	4008057065634	35	35	22	1



Silberfarben, brüniert
Silver coloured, burnished
Teinté argent, bruni

Möbelknopf
▶ Zinkdruckguss

Furniture knob
▶ Zinc die-cast

Bouton de meuble
▶ Zamak

Nr./No./Ref.	EAN	↔ mm	↕ mm	↗ mm	VE/PU/Qte
9 207 859	40080570906920	38	38	23	1



Brüniert
Burnished
Bruni

Möbelknopf
▶ Zinkdruckguss

Furniture knob
▶ Zinc die-cast

Bouton de meuble
▶ Zamak

Nr./No./Ref.	EAN	↗ mm	↘ mm	VE/PU/Qte
0 024 600	4008057246002	20	25	1



Silberfarben, brüniert
Silver coloured, burnished
Teinté argent, bruni

Möbelgriff
▶ Zinkdruckguss

Furniture handle
▶ Zinc die-cast

Poignée de meuble
▶ Zamak

Nr./No./Ref.	EAN	↔ mm	↔ mm	↕ mm	↗ mm	VE/PU/Qte
9 184 224	4008057024990	64	94	27	20	1



Silberfarben, brüniert / blau
Silver coloured, burnished / blue
Teinté argent, bruni / bleu

Möbelgriff
▶ Zinkdruckguss / Keramik

Furniture handle
▶ Zinc die-cast / ceramic

Poignée de meuble
▶ Zamak / céramique

Nr./No./Ref.	EAN	↔ mm	↔ mm	↕ mm	↗ mm	VE/PU/Qte
9 196 956	4008057066013	76	145	30	15,5	1



Möbelknopf

► Zinkdruckguss / Keramik

Furniture knob

► Zinc die-cast / ceramic

Bouton de meuble

► Zamak / céramique

Nr./No./Ref.	EAN	mm	mm	VE/PU/Qte
9 197 007	40080571066044	23	27	1

Silberfarben, brüniert / blau
Silver coloured, burnished / blue
Teinté argent, bruni / bleu



Möbelknopf

► Zinkdruckguss

Furniture knob

► Zinc die-cast

Bouton de meuble

► Zamak

Nr./No./Ref.	EAN	mm	mm	mm	VE/PU/Qte
1 9 208 484	40080571920315	58	20	38	1
2 9 208 485	40080571920322	58	20	38	1

1 Vermessingt, brüniert
Brass-plated, burnished
Laitonné, bruni

2 Silberfarben, brüniert
Silver coloured, burnished
Teinté argent, bruni



Möbelgriff

► Zinkdruckguss

Furniture handle

► Zinc die-cast

Poignée de meuble

► Zamak

Nr./No./Ref.	EAN	mm	mm	mm	mm	VE/PU/Qte
1 9 086 122	40080571403764	128	136	20	35	1
2 9 086 123	40080571403825	128	136	20	35	1

1 Silberfarben, brüniert
Silver coloured, burnished
Teinté argent, bruni

2 Vermessingt, brüniert
Brass-plated, burnished
Laitonné, bruni



Möbelgriff

► Zinkdruckguss

Furniture handle

► Zinc die-cast

Poignée de meuble

► Zamak

Nr./No./Ref.	EAN	mm	mm	mm	mm	VE/PU/Qte
1 9 211 879	40080571035248	96	110	14	28	1
2 9 211 874	40080571035224	96	110	14	28	1
3 9 211 878	40080571035231	96	110	14	28	1

1 Edelstahl-Optik
Stainless steel look
Aspect acier affiné

2 Vermessingt, brüniert
Brass-plated, burnished
Laitonné, bruni



3 Silberfarben, brüniert
Silver coloured, burnished
Teinté argent, bruni





Möbelgriff
▶ Zinkdruckguss

Furniture handle
▶ Zinc die-cast

Poignée de meuble
▶ Zamak

1 Edelstahl-Optik
Stainless steel look
Aspect acier affiné

2 Verchromt
Chrome-plated
Chromé

3 Vermessingt
Brass-plated
Laitonné



Nr./No./Ref.	EAN	↔ mm	↔ mm	↕ mm	↗ mm	VE/PU/Qte
1 9 196 492	40080571065863	128	185	22	32	1
2 9 196 493	40080571065870	128	185	22	32	1
3 9 196 494	40080571065887	128	185	22	32	1



Möbelknopf
▶ Zinkdruckguss

Furniture knob
▶ Zinc die-cast

Bouton de meuble
▶ Zamak

1 Edelstahl-Optik
Stainless steel look
Aspect acier affiné

2 Verchromt
Chrome-plated
Chromé

3 Vermessingt
Brass-plated
Laitonné



Nr./No./Ref.	EAN	↔ mm	↕ mm	↗ mm	VE/PU/Qte
1 9 196 454	40080571065658	25	25	20	1
2 9 196 455	40080571065665	25	25	20	1
3 9 196 456	40080571065672	25	25	20	1



Möbelgriff
▶ Zinkdruckguss

Furniture handle
▶ Zinc die-cast

Poignée de meuble
▶ Zamak

Silberfarben, brüniert
Silver coloured, burnished
Teinté argent, bruni

Nr./No./Ref.	EAN	↔ mm	↔ mm	↕ mm	↗ mm	VE/PU/Qte
9 208 472	40080571920223	128	154	19	27,5	1



Möbelgriff
▶ Zinkdruckguss

Furniture handle
▶ Zinc die-cast

Poignée de meuble
▶ Zamak

1 Vermessingt, brüniert
Brass-plated, burnished
Laitonné, bruni

2 Silberfarben, brüniert
Silver coloured, burnished
Teinté argent, bruni



Nr./No./Ref.	EAN	↔ mm	↔ mm	↕ mm	↗ mm	VE/PU/Qte
1 9 196 497	40080571065856	128	160	21	22	1
2 9 196 496	40080571065849	128	160	21	22	1



Möbelgriff
▶ Zinkdruckguss

Furniture handle
▶ Zinc die-cast

Poignée de meuble
▶ Zamak

Vermessingt, brüniert
Brass-plated, burnished
Laitonné, bruni

Nr./No./Ref.	EAN	↔ mm	↔ mm	↕ mm	↗ mm	VE/PU/Qte
9 196 498	40080571065894	96	120	18	21	1
9 196 499	40080571065900	128	152	18,5	23,5	1



Möbelgriff
▶ Zinkdruckguss

Furniture handle
▶ Zinc die-cast

Poignée de meuble
▶ Zamak

1 Vermessingt, brüniert
Brass-plated, burnished
Laitonné, bruni

2 Vermessingt, antik
Brass-plated, antique
Laitonné, antique



Nr./No./Ref.	EAN	↔ mm	↔ mm	↕ mm	↗ mm	VE/PU/Qte
1 9 215 099	40080571037129	96	132	20	23	1
2 9 215 100	40080571037136	96	132	20	23	1



Möbelgriff
▶ Zinkdruckguss

Furniture handle
▶ Zinc die-cast

Poignée de meuble
▶ Zamak

Vermessingt, brüniert
Brass-plated, burnished
Laitonné, bruni

Nr./No./Ref.	EAN	↔ mm	↔ mm	↕ mm	↗ mm	VE/PU/Qte
9 207 844	40080571906777	64	103	13,5	23	1
9 207 843	40080571906760	96	135	14	23	1



Möbelgriff
▶ Zinkdruckguss

Furniture handle
▶ Zinc die-cast

Poignée de meuble
▶ Zamak

Vermessingt, brüniert
Brass-plated, burnished
Laitonné, bruni

Nr./No./Ref.	EAN	↔ mm	↔ mm	↕ mm	↗ mm	VE/PU/Qte
9 157 247	40080571018524	96	125	11	23	1



Möbelgriff
▶ Zinkdruckguss / Kunststoff

Furniture handle
▶ Zinc die-cast / plastic

Poignée de meuble
▶ Zamak / plastique

Verchromt / weiß
Chrome-plated / white
Chromé / blanc

Nr./No./Ref.	EAN	↔ mm	↔ mm	↕ mm	↗ mm	VE/PU/Qte
9 196 495	40080571065603	32	81	24	25	1



Country



Wohlfühlen inmitten der Natur. Für natürliche Behaglichkeit sorgt die Griff-Kollektion COUNTRY. Ihre traditionellen Formen, in Kombination mit Naturmaterialien, lassen ein gemütliches und warmes Ambiente im Wohnraum entstehen.

Feeling at ease amid nature. The COUNTRY handle collection conjures a sense of natural homely comfort and warmth. Combined with natural materials, its traditional shapes create a cosy and warm ambience in the home.

Pour se sentir bien en pleine nature. La collection de poignées COUNTRY garantit un confort naturel. Ses formes traditionnelles combinées avec des matériaux naturels permettent de créer un habitat à ambiance chaleureuse et accueillante.



Möbelgriff

► Zinkdruckguss / Keramik

Furniture handle

► Zinc die-cast / ceramic

Poignée de meuble

► Zamak / céramique

1 Vermessingt / weiß mit Blumendekor
Brass-plated / white with flower decor
Laitonné / blanc avec fleurs

2 Vermessingt / weiß
Brass-plated / white
Laitonné / blanc



Nr./No./Ref.	EAN	↔ mm	↔ mm	↕ mm	↗ mm	VE/PU/Qte
1 0 015 605	4 008057 156059	76	126,5	18	30	1
2 0 015 616	4 008057 156165	76	126,5	18	30	1



Möbelknopf

► Keramik

Furniture knob

► Ceramic

Bouton de meuble

► Céramique

Weiß
White
Blanc

Nr./No./Ref.	EAN	↗ mm	↖ mm	VE/PU/Qte
0 007 150	4 008057 071503	25,5	30	1



Möbelknopf

► Keramik

Furniture knob

► Ceramic

Bouton de meuble

► Céramique

Weiß
White
Blanc

Nr./No./Ref.	EAN	↗ mm	↖ mm	VE/PU/Qte
0 007 152	4 008057 071529	30	38	1



Möbelknopf

► Keramik / Zinkdruckguss

Furniture knob

► Ceramic / zinc die-cast

Bouton de meuble

► Céramique / zamak

Weiß / vermessingt
White / brass-plated
Blanc / Laitonné

Nr./No./Ref.	EAN	↗ mm	↖ mm	VE/PU/Qte
0 007 175	4 008057 071758	37	32	1



Möbelknopf

► Keramik / Zinkdruckguss

Furniture knob

► Ceramic / zinc die-cast

Bouton de meuble

► Céramique / zamak

Weiß / vermessingt, brüniert
White / brass-plated, burnished
Blanc / laitonné, bruni

Nr./No./Ref.	EAN	↗ mm	↖ mm	VE/PU/Qte
0 015 612	4 008057 156127	25	26	1
0 015 611	4 008057 156110	24	32	1



Möbelknopf

► Keramik

Furniture knob

► Ceramic

Bouton de meuble

► Céramique

Weiß mit Blumendekor
White with flower decor
Blanc avec fleurs

Nr./No./Ref.	EAN	↗ mm	↖ mm	VE/PU/Qte
0 015 603	4 008057 156035	28	35	1



Möbelknopf
▷ Keramik

Furniture knob
▷ Ceramic

Bouton de meuble
▷ Céramique

Nr./No./Ref.	EAN	↔ mm	↕ mm	↗ mm	VE/PU/Qte
9 204 252	40080571031974	30	22	21	1

Weiß mit Blumendekor
White with flower decor
Blanc avec fleurs



Möbelknopf
▷ Keramik / Zinkdruckguss

Furniture knob
▷ Ceramic / zinc die-cast

Bouton de meuble
▷ Céramique / zamak

Nr./No./Ref.	EAN	↗ mm	↘ mm	VE/PU/Qte
9 204 253	40080571031981	25,5	27,5	1

Weiß mit Blumendekor / vermessingt, brüniert
White with flower decor / brass-plated, burnished
Blanc avec fleurs / laitonné, bruni



Möbelknopf
▷ Keramik

Furniture knob
▷ Ceramic

Bouton de meuble
▷ Céramique

Nr./No./Ref.	EAN	↗ mm	↘ mm	VE/PU/Qte
9 204 250	40080571031950	28	38	1

Weiß mit Blumendekor
White with flower decor
Blanc avec fleurs



Möbelknopf
▷ Keramik / Zinkdruckguss

Furniture knob
▷ Ceramic / zinc die-cast

Bouton de meuble
▷ Céramique / zamak

Nr./No./Ref.	EAN	↗ mm	↘ mm	VE/PU/Qte
9 204 248	40080571031943	25,5	27,5	1

Weiß mit Blumendekor / vermessingt, brüniert
White with flower decor / brass-plated, burnished
Blanc avec fleurs / laitonné, bruni



Möbelknopf
▷ Keramik

Furniture knob
▷ Ceramic

Bouton de meuble
▷ Céramique

Nr./No./Ref.	EAN	↗ mm	↘ mm	VE/PU/Qte
9 204 251	40080571031967	28	38	1

Weiß mit Dekor
White with decor
Blanc avec décor



Möbelknopf
▷ Keramik

Furniture knob
▷ Ceramic

Bouton de meuble
▷ Céramique

Nr./No./Ref.	EAN	↗ mm	↘ mm	VE/PU/Qte
9 204 246	40080571031936	23	32	1
9 204 245	40080571031929	28	38	1

Weiß, vintage
White, vintage
Blanc, vintage

Möbelknopf

▶ Keramik / Zinkdruckguss

Furniture knob

▶ Ceramic / zinc die-cast

Bouton de meuble

▶ Céramique / zamak

Nr./No./Ref.	EAN	mm	mm	VE/PU/Qte
9 204 223	4 008 057 103 191 2	25,5	27,5	1

Weiß, vintage / silberfarben, brüniert
 White, vintage / silver coloured, burnished
 Blanc, vintage / teinté argent, bruni

Möbelknopf

▶ Zinkdruckguss / Keramik

Furniture knob

▶ Zinc die-cast / ceramic

Bouton de meuble

▶ Zamak / céramique

Nr./No./Ref.	EAN	mm	mm	mm	mm	VE/PU/Qte
9 204 254	4 008 057 103 191 8	12	23	59	29	1

Vermessingt, brüniert / weiß mit Dekor
 Brass-plated, burnished / white with decor
 Laitonné, bruni / blanc avec décor

Möbelgriff

▶ Aluminium

Furniture handle

▶ Aluminium

Poignée de meuble

▶ Aluminium

Nr./No./Ref.	EAN	mm	mm	mm	mm	VE/PU/Qte
0 004 314	4 008 057 104 314 4	60	70	25	27	1

Neusilber eloxiert
 Argentan alloy
 Argent neuf

Möbelknopf

▶ Zinkdruckguss / Kunststoff

Furniture knob

▶ Zinc die-cast / plastic

Bouton de meuble

▶ Zamak / plastique

Nr./No./Ref.	EAN	mm	mm	mm	VE/PU/Qte
9 207 858	4 008 057 190 691 3	37	27	26	1

Vernickelt / Buche-Optik
 Nickel-plated / beech look
 Nickelé / aspect hêtre

Möbelgriff

▶ Zinkdruckguss / Kunststoff

Furniture handle

▶ Zinc die-cast / plastic

Poignée de meuble

▶ Zamak / plastique

Nr./No./Ref.	EAN	mm	mm	mm	mm	VE/PU/Qte
1 9 207 831	4 008 057 190 664 7	96	106	14	25	1
1 9 207 832	4 008 057 190 665 4	128	140	18	28	1
2 9 150 510	4 008 057 101 356 7	128	140	18	28	1

1 Vernickelt / Buche-Optik
 Nickel-plated / beech look
 Nickelé / Aspect hêtre

2 Vermessingt / Buche-Optik
 Brass-plated / beech look
 Laitonné / aspect hêtre





Einlassgriff
▶ Holz

Recessed handle
▶ Wood

Poignée encastrée insert
▶ Bois

Kiefer, roh
Pine, untreated
Pin, naturel

Nr./No./Ref.	EAN	↔ mm	↕ mm	↗ mm	VE/PU/Qte
9 158 617	4008057022040	110	40	15	1



Möbelgriff
▶ Holz

Furniture handle
▶ Wood

Poignée de meuble
▶ Bois

Kiefer, roh
Pine, untreated
Pin, naturel

Nr./No./Ref.	EAN	↔ mm	↔ mm	↕ mm	↗ mm	VE/PU/Qte
9 158 616	4008057022033	64	111	55	18	1



Möbelgriff
▶ Holz

Furniture handle
▶ Wood

Poignée de meuble
▶ Bois

Kiefer, roh
Pine, untreated
Pin, naturel

Nr./No./Ref.	EAN	↔ mm	↔ mm	↕ mm	↗ mm	VE/PU/Qte
9 158 618	4008057022057	32	50	16	25	1



Möbelgriff
▶ Holz

Furniture handle
▶ Wood

Poignée de meuble
▶ Bois

1 Buche, lackiert
Beech, laquered
Hêtre, verni

2 Kiefer, roh
Pine, untreated
Pin, naturel



Nr./No./Ref.	EAN	↔ mm	↔ mm	↕ mm	↗ mm	VE/PU/Qte
1 9 158 610	4008057021579	64	80	16	33	1
1 9 158 612	4008057021890	96	112	16	33	1
2 9 158 609	4008057021548	64	80	16	33	1
2 9 158 611	4008057021586	96	112	16	33	1



Möbelgriff
▶ Holz

Furniture handle
▶ Wood

Poignée de meuble
▶ Bois

1 Kiefer, roh
Pine, untreated
Pin, naturel

2 Buche, lackiert
Beech, laquered
Hêtre, verni



Nr./No./Ref.	EAN	↔ mm	↔ mm	↕ mm	↗ mm	VE/PU/Qte
1 9 158 613	4008057022002	64	76	14	28	1
1 9 158 614	4008057022019	96	119	17	28	1
2 9 158 615	4008057022026	96	119	17	28	1



Möbelgriff
▶ Holz

Furniture handle
▶ Wood

Poignée de meuble
▶ Bois

Kiefer, roh
Pine, untreated
Pin, naturel

Nr./No./Ref.	EAN	↔ mm	↔ mm	↕ mm	↗ mm	VE/PU/Qte
9 158 622	40080571022095	64	97,5	17	25	1



Möbelgriff
▶ Holz

Furniture handle
▶ Wood

Poignée de meuble
▶ Bois

Buche, roh
Beech, untreated
Hêtre, naturel

Nr./No./Ref.	EAN	↔ mm	↔ mm	↕ mm	↗ mm	VE/PU/Qte
9 158 619	40080571022064	96	108	16	35	1



Möbelgriff
▶ Holz

Furniture handle
▶ Wood

Poignée de meuble
▶ Bois

Buche, lackiert
Beech, laquered
Hêtre, verni

Nr./No./Ref.	EAN	↔ mm	↔ mm	↕ mm	↗ mm	VE/PU/Qte
9 208 479	40080571022078	64	91	11	30	1
9 208 480	40080571022085	96	127	11	32	1



Möbelgriff
▶ Holz

Furniture handle
▶ Wood

Poignée de meuble
▶ Bois

Buche, lackiert
Beech, laquered
Hêtre, verni

Nr./No./Ref.	EAN	↔ mm	↔ mm	↕ mm	↗ mm	VE/PU/Qte
9 158 620	40080571022071	96	125,5	10	29	1
9 208 476	40080571022061	128	162	10	29	1



Möbelgriff
▶ Holz

Furniture handle
▶ Wood

Poignée de meuble
▶ Bois

Buche, roh
Beech, untreated
Hêtre, naturel

Nr./No./Ref.	EAN	↔ mm	↔ mm	↕ mm	↗ mm	VE/PU/Qte
9 158 621	40080571022088	32	60	60	20	1



Möbelgriff
▶ Holz

Furniture handle
▶ Wood

Poignée de meuble
▶ Bois

Eiche, roh
Oak, untreated
Chêne, naturel

Nr./No./Ref.	EAN	↔ mm	↔ mm	↕ mm	↗ mm	VE/PU/Qte
9 193 751	40080571027489	32	64	19,5	25,5	1
9 193 752	40080571027496	128	160	19,5	25,5	1



Möbelknopf
▶ Holz

Furniture knob
▶ Wood

Bouton de meuble
▶ Bois

- 1 Kiefer, roh
Pine, untreated
Pin, naturel

- 2 Kiefer, lackiert
Pine, lacquered
Pin, verni

- 3 Eiche, roh
Oak, untreated
Chêne, naturel



Nr./No./Ref.	EAN	mm	mm	VE/PU/Qte
1 9 158 583	40080571020749	36	40	1
2 9 158 585	40080571020763	36	40	1
3 9 158 584	40080571020756	36	40	1



Möbelknopf
▶ Holz

Furniture knob
▶ Wood

Bouton de meuble
▶ Bois

- Eiche, roh
Oak, untreated
Chêne, naturel

Nr./No./Ref.	EAN	mm	mm	VE/PU/Qte
9 158 586	40080571020770	39,5	44	1



Möbelknopf
▶ Holz

Furniture knob
▶ Wood

Bouton de meuble
▶ Bois

- 1 Buche, roh
Beech, untreated
Hêtre, naturel

- 2 Buche, lackiert
Beech, laquered
Hêtre, verni



Nr./No./Ref.	EAN	mm	mm	VE/PU/Qte
1 9 208 494	40080571920407	29	44	1
2 9 208 491	40080571920377	29	44	1



Möbelknopf
▶ Holz

Furniture knob
▶ Wood

Bouton de meuble
▶ Bois

- 1 Kiefer, roh
Pine, untreated
Pin, naturel

- 2 Kiefer, lackiert
Pine, lacquered
Pin, verni

- 3 Buche, lackiert
Beech, laquered
Hêtre, verni



Nr./No./Ref.	EAN	mm	mm	VE/PU/Qte
1 9 208 504	40080571920506	29	44	1
2 9 208 498	40080571920445	29	44	1
3 9 208 500	40080571920469	29	44	1



Möbelknopf
▶ Holz

Furniture knob
▶ Wood

Bouton de meuble
▶ Bois

Nr./No./Ref.	EAN	mm	mm	VE/PU/Qte
1 9 158 581	40080571020725	27	28	1
2 9 158 580	40080571020718	27	28	1
3 9 158 582	40080571020732	27	28	1

1 Kiefer, roh
Pine, untreated
Pin, naturel

2 Kiefer, lackiert
Pine, lacquered
Pin, verni

3 Eiche, roh
Oak, untreated
Chêne, naturel



Möbelknopf
▶ Holz

Furniture knob
▶ Wood

Bouton de meuble
▶ Bois

Nr./No./Ref.	EAN	mm	mm	VE/PU/Qte
1 9 208 503	40080571920490	29	35	1
2 9 208 499	40080571920452	29	35	1
3 9 208 493	40080571920391	29	35	1
4 9 208 495	40080571920414	29	35	1
5 9 208 492	40080571920384	29	35	1

1 Eiche, lackiert
Oak, laquered
Chêne, verni

2 Kiefer, roh
Pine, untreated
Pin, naturel

3 Kiefer, lackiert
Pine, lacquered
Pin, verni

4 Buche, roh
Beech, untreated
Hêtre, naturel

5 Buche, lackiert
Beech, laquered
Hêtre, verni



Möbelknopf
▶ Holz

Furniture knob
▶ Wood

Bouton de meuble
▶ Bois

Nr./No./Ref.	EAN	mm	mm	VE/PU/Qte
9 158 589	40080571020800	35	38	1

Kiefer, lackiert
Pine, lacquered
Pin, verni



Möbelknopf
▶ Holz

Furniture knob
▶ Wood

Bouton de meuble
▶ Bois

1 Kiefer, roh
Pine, untreated
Pin, naturel

Nr./No./Ref.	EAN	mm	mm	VE/PU/Qte
1 9 158 602	40080571021340	26	34	1
2 9 158 603	40080571021357	26	34	1

2 Buche, roh
Beech, untreated
Hêtre, naturel



Möbelknopf
▶ Holz

Furniture knob
▶ Wood

Bouton de meuble
▶ Bois

Buche, lackiert
Beech, laquered
Hêtre, verni

Nr./No./Ref.	EAN	mm	mm	VE/PU/Qte
9 158 600	40080571020921	28	34	1



Möbelknopf
▶ Holz

Furniture knob
▶ Wood

Bouton de meuble
▶ Bois

Kiefer, roh
Pine, untreated
Pin, naturel

Nr./No./Ref.	EAN	mm	mm	VE/PU/Qte
9 158 601	40080571021333	30	43	1



Möbelknopf
▶ Holz

Furniture knob
▶ Wood

Bouton de meuble
▶ Bois

Kiefer, lackiert
Pine, lacquered
Pin, verni

Nr./No./Ref.	EAN	mm	mm	VE/PU/Qte
9 158 594	40080571020893	35	20	1



Möbelknopf
▶ Holz

Furniture knob
▶ Wood

Bouton de meuble
▶ Bois

Kiefer, lackiert
Pine, lacquered
Pin, verni

Nr./No./Ref.	EAN	mm	mm	VE/PU/Qte
9 158 595	40080571020909	30	23	1



Möbelknopf
▶ Holz

Furniture knob
▶ Wood

Bouton de meuble
▶ Bois

1 Eiche, roh
Oak, untreated
Chêne, naturel

2 Kiefer, roh
Pine, untreated
Pin, naturel



Nr./No./Ref.	EAN	mm	mm	VE/PU/Qte
1 9 158 605	4008057021401	25	22	1
2 9 158 604	4008057021364	25	22	1
2 9 158 606	4008057021418	25	22	5



Möbelknopf
▶ Holz

Furniture knob
▶ Wood

Bouton de meuble
▶ Bois

1 Eiche, rustikal
Oak, rustic
Chêne, rustique

2 Eiche, roh
Oak, untreated
Chêne, naturel



Nr./No./Ref.	EAN	mm	mm	VE/PU/Qte
1 9 157 937	4008057019835	25	25	1
2 9 157 935	4008057019828	25	25	1



Möbelknopf
▶ Holz

Furniture knob
▶ Wood

Bouton de meuble
▶ Bois

Eiche, roh
Oak, untreated
Chêne, naturel

Nr./No./Ref.	EAN	mm	mm	VE/PU/Qte
9 158 607	4008057021425	25	25	1



Möbelknopf
▶ Holz

Furniture knob
▶ Wood

Bouton de meuble
▶ Bois

1 Eiche, roh
Oak, untreated
Chêne, naturel

2 Eiche, rustikal
Oak, rustic
Chêne, rustique



3 Kiefer, lackiert
Pine, lacquered
Pin, verni



4 Kiefer, weiß lackiert
Pine, white lacquered
Pin, blanc lackiert



Nr./No./Ref.	EAN	mm	mm	VE/PU/Qte
1 9 158 598	4008057020930	28,5	29	1
2 9 158 597	4008057020923	28,5	29	1
3 9 158 599	4008057020947	28,5	29	1
4 9 158 596	4008057020916	28,5	29	1



Möbelknopf
▶ Holz

Furniture knob
▶ Wood

Bouton de meuble
▶ Bois

Kiefer, lackiert
Pine, lacquered
Pine, verni

Nr./No./Ref.	EAN	↕ mm	↻ mm	VE/PU/Qte
9 158 587	4008057020787	30	18	1



Möbelknopf
▶ Holz

Furniture knob
▶ Wood

Bouton de meuble
▶ Bois

1 Eiche, roh
Oak, untreated
Chêne, naturel

2 Eiche, rustikal
Oak, rustic
Chêne, rustique



Nr./No./Ref.	EAN	↕ mm	↻ mm	VE/PU/Qte
1 9 157 933	4008057019804	30	16	1
2 9 157 934	4008057019811	30	16	1



Möbelknopf
▶ Holz

Furniture knob
▶ Wood

Bouton de meuble
▶ Bois

1 Kiefer, roh
Pine, untreated
Pin, naturel

2 Kiefer, lackiert
Pine, lacquered
Pine, verni

3 Buche, roh
Beech, untreated
Hêtre, naturel

4 Buche, lackiert
Beech, laquered
Hêtre, verni



Nr./No./Ref.	EAN	↕ mm	↻ mm	VE/PU/Qte
1 9 158 588	4008057020794	32	30	1
1 9 158 593	4008057020848	36	35	1
2 9 208 502	4008057020483	36	35	1
3 9 208 501	4008057020476	36	35	1
4 9 208 496	4008057020421	36	35	1



Möbelknopf
▶ Holz

Furniture knob
▶ Wood

Bouton de meuble
▶ Bois

Kiefer, roh
Pine, untreated
Pin, naturel

Nr./No./Ref.	EAN	↔ mm	↕ mm	↕ mm	VE/PU/Qte
9 158 608	4008057021500	50	50	26	1



Möbelknopf
▶ Zinkdruckguss / Holz

Furniture knob
▶ Zinc die-cast / wood

Bouton de meuble
▶ Zamak / bois

Aluminium-Optik / Buche, lackiert
Aluminium look / beech, laquered
Aspect aluminium / hêtre, verni

Nr./No./Ref.	EAN	↕ mm	↻ mm	VE/PU/Qte
0 024 012	4008057240123	27	33	1







Möbelknopf
▶ Holz

Furniture knob
▶ Wood

Bouton de meuble
▶ Bois

Buche, roh
Beech, untreated
Hêtre, nature

Nr./No./ Ref.	EAN	 mm	 mm	VE/PU/Qte	
9 208 497		26	33,5	1	



Classic

Altes erscheint wieder in neuem Glanz. Klassische Formen, Farben und Materialien finden sich in der Griff-Kollektion CLASSIC wieder. Einfache oder extravagante Möbelstücke werden mit dem zeitlosen Design der Griffkollektion zu neuem Leben erweckt.

Sparkle and splendour return to old pieces. Classic shapes, colours and materials are reflected in the CLASSIC handle collection. This handle collection's timeless design gives simple or extravagant items of furniture a new lease of life.

Les objets anciens apparaissent dans toute leur splendeur. La collection de poignées CLASSIC est empreinte de formes, de coloris et de matériaux classiques. Le design intemporel de la collection de poignées donne une nouvelle vie aux meubles simples ou extravagants.

Möbelgriff
▷ Stahl

1 Vernickelt
Nickel-plated
Nickelé

2 Verchromt
Chrome-plated
Chromé

3 Vermessingt
Brass-plated
Laitonné

Furniture handle
▷ Steel

Poignée de meuble
▷ Acier

Nr./No./Ref.	EAN	↔ mm	↔ mm	↕ mm	↗ mm	VE/PU/Qte
1 0 004 077	40080571040778	64	71	8	28	1
1 0 004 078	40080571040785	96	104,5	8	28	1
2 0 004 080	40080571040808	64	71	8	28	1
2 0 004 079	40080571040792	96	104,5	8	28	1
3 0 003 710	40080571037105	96	104,5	8	28	1

Möbelgriff
▷ Stahl

1 Verchromt
Chrome-plated
Chromé

2 Vernickelt
Nickel-plated
Nickelé

Furniture handle
▷ Steel

Poignée de meuble
▷ Acier

Nr./No./Ref.	EAN	↔ mm	↔ mm	↕ mm	↗ mm	VE/PU/Qte
1 0 004 075	40080571040754	64	74	10	30	1
1 0 004 076	40080571040761	96	106	10	30	1
1 0 004 101	40080571041010	128	138	10	30	1
2 0 004 022	40080571040228	128	138	10	30	1

Möbelgriff
▷ Zinkdruckguss

1 Aluminium-Optik
Aluminium look
Aspect aluminium

2 Edelstahl-Optik
Stainless steel look
Aspect acier affiné

3 Vernickelt
Nickel-plated
Nickelé

Furniture handle
▷ Zinc die-cast

Poignée de meuble
▷ Zamak

Nr./No./Ref.	EAN	↔ mm	↔ mm	↕ mm	↗ mm	VE/PU/Qte
1 9 196 511	40080571065818	96	140	15	27	1
2 9 196 510	40080571065801	96	140	15	27	1
3 9 196 509	40080571065795	96	140	15	27	1

Möbelgriff
▷ Zinkdruckguss

1 Edelstahl-Optik
Stainless steel look
Aspect acier affiné

2 Vermessingt, brüniert
Brass-plated, burnished
Laitonné, bruni

Furniture handle
▷ Zinc die-cast

Poignée de meuble
▷ Zamak

Nr./No./Ref.	EAN	↔ mm	↔ mm	↕ mm	↗ mm	VE/PU/Qte
1 9 211 880	40080571035255	96	126	12	24	1
2 9 211 881	40080571035262	96	126	12	24	1



Möbelgriff
▶ Zinkdruckguss

Furniture handle
▶ Zinc die-cast

Poignée de meuble
▶ Zamak

1 Edelstahl-Optik
Stainless steel look
Aspect acier affiné

2 Aluminium-Optik
Aluminium look
Aspect aluminium



Nr./No./Ref.	EAN	↔ mm	↔ mm	↕ mm	↗ mm	VE/PU/Qte
1 9 196 512	40080571065825	128	179	18	30	1
2 9 196 513	40080571065832	128	179	18	30	1



Möbelgriff
▶ Zinkdruckguss

Furniture handle
▶ Zinc die-cast

Poignée de meuble
▶ Zamak

1 Aluminium-Optik
Aluminium look
Aspect aluminium

2 Vernickelt
Nickel-plated
Nickelé



Nr./No./Ref.	EAN	↔ mm	↔ mm	↕ mm	↗ mm	VE/PU/Qte
1 9 207 837	40080571906708	16	42,5	21	24,5	1
2 9 207 836	40080571906692	16	42,5	21	24,5	1



Möbelgriff
▶ Zinkdruckguss

Furniture handle
▶ Zinc die-cast

Poignée de meuble
▶ Zamak

1 Aluminium-Optik
Aluminium look
Aspect aluminium

2 Vernickelt
Nickel-plated
Nickelé



3 Verchromt
Chrome-plated
Chromé



Nr./No./Ref.	EAN	↔ mm	↔ mm	↕ mm	↗ mm	VE/PU/Qte
1 9 207 870	40080571907033	64	87,5	12,5	20	1
1 0 014 128	40080571141284	96	125	18	25	1
1 9 207 886	40080571907194	128	160	18	28	1
2 9 207 871	40080571907040	64	87,5	12,5	20	1
2 9 207 884	40080571907170	96	125	18	25	1
2 9 207 887	40080571907200	128	160	18	28	1
3 9 207 873	40080571907064	64	87,5	12,5	20	1
3 9 207 883	40080571907163	96	125	18	25	1
3 9 207 885	40080571907187	128	160	18	28	1



Möbelgriff
▶ Zinkdruckguss

Furniture handle
▶ Zinc die-cast

Poignée de meuble
▶ Zamak

1 Vernickelt
Nickel-plated
Nickelé

2 Aluminium-Optik
Aluminium look
Aspect aluminium



Nr./No./Ref.	EAN	↔ mm	↔ mm	↕ mm	↗ mm	VE/PU/Qte
1 9 207 846	40080571906791	96	130	15	26	1
1 9 207 848	40080571906814	128	163	15	27	1
2 9 207 845	40080571906784	96	130	15	26	1
2 9 207 847	40080571906807	128	163	15	27	1

Classic



Möbelgriff
▶ Stahl

Edelstahl-Optik
Stainless steel look
Aspect acier affiné

Furniture handle
▶ Steel

Poignée de meuble
▶ Acier

Nr./No./Ref.	EAN	↔ mm	↔ mm	↗ mm	↖ mm	VE/PU/Qte
0 015 968	4008057159685	96	150	32	12	1
0 015 969	4008057159692	128	189	32	12	1
9 196 955	4008057065962	160	220	32	12	1
9 208 449	40080571908320	224	280	32	12	1
9 208 450	40080571920100	320	400	32	12	1
9 196 954	4008057065955	416	477	32	12	1
9 150 541	4008057013574	448	490	36	12	1



Möbelgriff
▶ Stahl

Aluminium-Optik
Aluminium look
Aspect aluminium

Furniture handle
▶ Steel

Poignée de meuble
▶ Acier

Nr./No./Ref.	EAN	↔ mm	↔ mm	↗ mm	↖ mm	VE/PU/Qte
9 202 454	4008057066860	96	137	32	12	1
9 196 958	4008057066235	128	189	32	12	1
9 196 959	4008057066242	160	220	32	12	1
9 208 451	40080571920117	224	265	32	12	1
9 208 452	40080571920124	320	360	32	12	1



Möbelgriff
▶ Stahl

1 Edelstahl-Optik
Stainless steel look
Aspect acier affiné

2 Aluminium-Optik
Aluminium look
Aspect aluminium



Furniture handle
▶ Steel

Poignée de meuble
▶ Acier

Nr./No./Ref.	EAN	↔ mm	↔ mm	↗ mm	↖ mm	VE/PU/Qte
1 9 207 830	40080571906630	64	94	33,5	10	1
1 9 207 827	40080571906609	96	126	33,5	10	1
2 9 207 829	40080571906623	64	94	33,5	10	1
2 9 207 828	40080571906616	96	126	33,5	10	1



Möbelgriff
▶ Zinkdruckguss

1 Aluminium-Optik
Aluminium look
Aspect aluminium

2 Edelstahl-Optik
Stainless steel look
Aspect acier affiné

3 Vernickelt
Nickel-plated
Nickelé



Furniture handle
▶ Zinc die-cast

Poignée de meuble
▶ Zamak

Nr./No./Ref.	EAN	↔ mm	↔ mm	↕ mm	↗ mm	VE/PU/Qte
1 9 196 504	4008057065740	96	135	12	23	1
1 9 196 505	4008057065757	128	170	14	23	1
2 9 196 502	4008057065726	96	135	12	23	1
2 9 196 503	4008057065733	128	170	14	23	1
3 9 196 500	4008057065702	96	135	12	23	1
3 9 196 501	4008057065719	128	170	14	23	1



Möbelgriff
▶ Zinkdruckguss

Furniture handle
▶ Zinc die-cast

Poignée de meuble
▶ Zamak

1 Aluminium-Optik
Aluminium look
Aspect aluminium

2 Verchromt
Chrome-plated
Chromé

3 Vernickelt
Nickel-plated
Nickelé



Nr./No./Ref.	EAN	mm	mm	mm	mm	VE/PU/Qte
1 9 207 882	40080571907156	64	104	14	21	1
1 9 207 867	40080571907002	96	137	14	23	1
2 9 207 875	40080571907088	96	137	14	23	1
3 9 207 878	40080571907118	64	104	14	21	1
3 9 207 866	40080571906999	96	137	14	23	1



Möbelgriff
▶ Stahl

Furniture handle
▶ Steel

Poignée de meuble
▶ Acier

1 Verchromt
Chrome-plated
Chromé

2 Edelstahl-Optik
Stainless steel look
Aspect acier affiné

3 Aluminium-Optik
Aluminium look
Aspect aluminium

4 Vermessingt
Brass-plated
Laitonné



Nr./No./Ref.	EAN	mm	mm	mm	mm	VE/PU/Qte
1 9 208 453	40080571920131	96	112,5	30	10	1
2 9 163 233	40080571023290	96	112,5	30	10	1
2 9 163 239	40080571023306	128	149	30	10	1
3 9 208 454	40080571920148	96	112,5	30	10	1
3 9 208 456	40080571920162	128	149	30	10	1
4 9 208 455	40080571920155	96	112,5	30	10	1



Möbelgriff
▶ Stahl

Furniture handle
▶ Steel

Poignée de meuble
▶ Acier

Edelstahl-Optik
Stainless steel look
Aspect acier affiné

Nr./No./Ref.	EAN	mm	mm	mm	mm	VE/PU/Qte
0 014 155	40080571141550	96	106	30	10	1
0 014 156	40080571141567	128	138	30	10	1

Möbelgriff
▶ Zinkdruckguss



1 Verchromt
Chrome-plated
Chromé



2 Edelstahl-Optik
Stainless steel look
Aspect acier affiné











3 Aluminium-Optik
Aluminium look
Aspect aluminium



4 Vernickelt
Nickel-plated
Nickelé

Furniture handle
▶ Zinc die-cast

Poignée de meuble
▶ Zamak

Nr./No./Ref.	EAN	↔ mm	↔ mm	↕ mm	↗ mm	VE/PU/Qte
1 9 202 430	40080571066891	96	116	11	28	1 
1 9 202 431	40080571066907	128	148	11	28	1 
2 9 202 428	40080571066853	96	116	11	28	1 
2 9 202 429	40080571066884	128	148	11	28	1 
3 9 202 436	40080571066983	96	116	11	28	1 
3 9 202 435	40080571066969	128	148	11	28	1 
4 9 202 437	40080571067003	96	116	11	28	1 
4 9 202 434	40080571066952	128	148	11	28	1 

Möbelgriff
▶ Zinkdruckguss



1 Schwarz vernickelt
Black nickel-plated
Nickel noir



2 Aluminium-Optik
Aluminium look
Aspect aluminium







3 Verchromt
Chrome-plated
Chromé



4 Vermessingt
Brass-plated
Laitonné

Furniture handle
▶ Zinc die-cast

Poignée de meuble
▶ Zamak

Nr./No./Ref.	EAN	↔ mm	↔ mm	↕ mm	↗ mm	VE/PU/Qte
1 9 207 872	40080571907057	96	127	12	26	1 
2 9 207 868	40080571907019	96	127	12	26	1 
3 9 207 876	40080571907095	96	127	12	26	1 
4 9 207 880	40080571907132	96	127	12	26	1 

Möbelgriff
▶ Zinkdruckguss



Vernickelt
Nickel-plated
Nickelé

Furniture handle
▶ Zinc die-cast

Poignée de meuble
▶ Zamak

Nr./No./Ref.	EAN	↔ mm	↔ mm	↕ mm	↗ mm	VE/PU/Qte
9 150 608	40080571013598	96	122	19	23	1 

Möbelgriff
▶ Zinkdruckguss



Aluminium-Optik
Aluminium look
Aspect aluminium

Furniture handle
▶ Zinc die-cast

Poignée de meuble
▶ Zamak

Nr./No./Ref.	EAN	↔ mm	↔ mm	↕ mm	↗ mm	VE/PU/Qte
9 207 838	40080571906715	32	50	18,5	20	1 



Einlassgriff
▶ Stahl

Recessed handle
▶ Steel

Poignée encastrée insert
▶ Acier

1 Verchromt
Chrome-plated
Chromé

2 Vernickelt
Nickel-plated
Nickelé

3 Goldfarben
Gold coloured
Teinte dorée



Nr./No./Ref.	EAN	mm	mm	mm	VE/PU/Qte
1 9 100 310	40080571001007	10,5	35	41	1
2 9 100 390	40080571003230	10,5	35	41	1
3 9 100 384	40080571003223	10,5	35	41	1



Möbelgriff
▶ Zinkdruckguss

Furniture handle
▶ Zinc die-cast

Poignée de meuble
▶ Zamak

1 Vermessingt, brüniert
Brass-plated, burnished
Laitonné, bruni

2 Vernickelt
Nickel-plated
Nickelé

3 Aluminium-Optik
Aluminium look
Aspect aluminium



Nr./No./Ref.	EAN	mm	mm	mm	mm	VE/PU/Qte
1 9 211 322	40080571035187	96	107	42 / 30,5	12,5	1
2 9 211 323	40080571035194	96	107	42 / 30,5	12,5	1
3 9 211 324	40080571035200	96	107	42 / 30,5	12,5	1



Möbelknopf
▶ Zinkdruckguss

Furniture knob
▶ Zinc die-cast

Bouton de meuble
▶ Zamak

1 Aluminium-Optik
Aluminium look
Aspect aluminium

2 Verchromt
Chrome-plated
Chromé

3 Vernickelt
Nickel-plated
Nickelé

4 Vermessingt
Brass-plated
Laitonné



Nr./No./Ref.	EAN	mm	mm	VE/PU/Qte
1 9 207 853	40080571906869	21	22	1
2 9 207 852	40080571906852	21	22	1
3 9 207 855	40080571906883	21	22	1
4 9 150 440	40080571013437	21	22	1



Möbelknopf
▶ Zinkdruckguss

Furniture knob
▶ Zinc die-cast

Bouton de meuble
▶ Zamak

1 Edelstahl-Optik
Stainless steel look
Aspect acier affiné

Nr./No./Ref.	EAN	↕ mm	↻ mm	VE/PU/Qte
1 9 197 003	40080571065986	36	29	1
2 9 197 004	40080571065993	36	29	1

2 Verchromt
Chrome-plated
Chromé



Möbelknopf
▶ Zinkdruckguss

Furniture knob
▶ Zinc die-cast

Bouton de meuble
▶ Zamak

1 Aluminium-Optik
Aluminium look
Aspect aluminium

Nr./No./Ref.	EAN	↕ mm	↻ mm	VE/PU/Qte
1 9 207 851	40080571906845	30	21	1
2 9 207 850	40080571906838	30	21	1
3 9 207 854	40080571906876	30	21	1
4 9 150 504	40080571013536	30	21	1

2 Verchromt
Chrome-plated
Chromé



3 Vernickelt
Nickel-plated
Nickelé



4 Vermessingt
Brass-plated
Laitonné



Möbelknopf
▶ Zinkdruckguss

Furniture knob
▶ Zinc die-cast

Bouton de meuble
▶ Zamak

1 Vermessingt
Brass-plated
Laitonné

Nr./No./Ref.	EAN	↕ mm	↻ mm	VE/PU/Qte
1 9 150 483	40080571013482	28	17	1
2 9 207 860	40080571906937	28	17	1

2 Aluminium-Optik
Aluminium look
Aspect aluminium



Möbelknopf
▶ Zinkdruckguss

Furniture knob
▶ Zinc die-cast

Bouton de meuble
▶ Zamak

1 Verchromt
Chrome-plated
Chromé

Nr./No./Ref.	EAN	↕ mm	↻ mm	VE/PU/Qte
1 0 015 767	40080571157674	22	15	1
2 0 015 768	40080571157681	22	15	1

2 Edelstahl-Optik
Stainless steel look
Aspect acier affiné





Möbelknopf
▶ Aluminium

Furniture knob
▶ Aluminium

Bouton de meuble
▶ Aluminium

1 Edelstahl-Optik
Stainless steel look
Aspect acier affiné

2 Verchromt
Chrome-plated
Chromé

3 Vermessingt
Brass-plated
Laitonné



Nr./No./Ref.	EAN	mm	mm	VE/PU/Qte
1 9 197 002	40080571065979	30	30	1
2 9 197 011	40080571066082	30	30	1
3 9 197 012	40080571066099	30	30	1



Möbelknopf
▶ Zinkdruckguss

Furniture knob
▶ Zinc die-cast

Bouton de meuble
▶ Zamak

Edelstahl-Optik
Stainless steel look
Aspect acier affiné

Nr./No./Ref.	EAN	mm	mm	VE/PU/Qte
0 015 981	40080571159814	25	15	1



Möbelknopf
▶ Zinkdruckguss

Furniture knob
▶ Zinc die-cast

Bouton de meuble
▶ Zamak

1 Verchromt
Chrome-plated
Chromé

2 Edelstahl-Optik
Stainless steel look
Aspect acier affiné

3 Vermessingt
Brass-plated
Laitonné



Nr./No./Ref.	EAN	mm	mm	VE/PU/Qte
1 0 015 986	40080571159869	21	15	1
1 0 015 983	40080571159838	28	20	1
2 0 015 987	40080571159876	21	15	1
2 9 208 487	40080571920346	28	20	1
3 0 015 985	40080571159852	21	15	1
3 0 015 982	40080571159821	28	20	1



Möbelknopf
▶ Zinkdruckguss

Furniture knob
▶ Zinc die-cast

Bouton de meuble
▶ Zamak

1 Aluminium-Optik
Aluminium look
Aspect aluminium

2 Vernickelt
Nickel-plated
Nickelé



Nr./No./Ref.	EAN	mm	mm	VE/PU/Qte
1 0 014 121	40080571141215	24	28	1
1 9 207 881	40080571907149	27,5	33	1
2 9 207 863	40080571906968	24	28	1
2 9 207 864	40080571906975	27,5	33	1



Möbelknopf
▶ Zinkdruckguss

Furniture knob
▶ Zinc die-cast

Bouton de meuble
▶ Zamak

1 Vernickelt
Nickel-plated
Nickelé

Nr./No./Ref.	EAN	↔ mm	↕ mm	↗ mm	VE/PU/Qte
1 9 196 480	4008057065689	28	18	22	1
2 9 196 491	4008057065696	28	18	22	1

2 Aluminium-Optik
Aluminium look
Aspect aluminium



Möbelknopf
▶ Zinkdruckguss

Furniture knob
▶ Zinc die-cast

Bouton de meuble
▶ Zamak

1 Verchromt
Chrome-plated
Chromé

Nr./No./Ref.	EAN	↗ mm	↖ mm	VE/PU/Qte
1 9 207 862	4008057906951	21,5	32	1
2 9 207 861	4008057906944	21,5	32	1

2 Vernickelt
Nickel-plated
Nickelé



Möbelknopf
▶ Zinkdruckguss

Furniture knob
▶ Zinc die-cast

Bouton de meuble
▶ Zamak

Vernickelt
Nickel-plated
Nickelé

Nr./No./Ref.	EAN	↔ mm	↕ mm	↗ mm	VE/PU/Qte
9 207 856	4008057906890	28	18	23	1



Möbelknopf
▶ Zinkdruckguss

Furniture knob
▶ Zinc die-cast

Bouton de meuble
▶ Zamak

Vernickelt
Nickel-plated
Nickelé

Nr./No./Ref.	EAN	↔ mm	↕ mm	↗ mm	VE/PU/Qte
9 207 857	4008057906906	27	24	23	1



Glastürgriff mit Klemmschraube
▶ Erforderlich ist eine Fuge von 3 mm
▶ Zinkdruckguss

Glass door handle with clamping screw
▶ A reveal of 3 mm is required
▶ Zinc die-cast

Poignée de porte en verre avec vis de serrage
▶ Il faut un jeu de 3 mm
▶ Zamak

Vernickelt
Nickel-plated
Nickelé

Nr./No./Ref.	EAN	↔ mm	↕ mm	↗ mm	⊥ mm	VE/PU/Qte
9 113 120	4008057150651	26	20	20	≤6	1



Colours & Kids



Nicht nur im Kinderzimmer ist die Griff-Kollektion COLOURS & KIDS ein Blickfang. Das farbenfrohe und verspielte Design dieser Griff-Kollektion verleiht jedem Möbelstück einen frischen Charakter, ganz nach den persönlichen Vorstellungen seines Besitzers.

The COLOURS & KIDS handle collection not only makes an eyecatcher in children's rooms. The colourful and playful design of this handle collection brings a fresh look to any piece of furniture, perfectly in keeping with the personal taste of its owner.

La collection de poignées COLOURS & KIDS n'attire pas seulement tous les regards dans la chambre des enfants. Le design ludique et coloré de cette collection de poignées donne à chaque meuble un caractère frais faisant ressortir la personnalité de son propriétaire.



Möbelknopf
▶ Holz

Furniture knob
▶ Wood

Bouton de meuble
▶ Bois

1 Kiefer, pink lackiert
Pine, pink laquered
Pin, fuchsia laqué

2 Kiefer, grün lackiert
Pine, green laquered
Pin, vert laqué

3 Kiefer, hellblau lackiert
Pine, pale blue laquered
Pin, bleu clair laqué



Nr./No./Ref.	EAN	mm	mm	VE/PU/Qte
1 9 158 590	40080571020817	36	35	1
2 9 158 591	40080571020824	36	35	1
3 9 158 592	40080571020831	36	35	1



Möbelknopf
▶ Keramik / Stahl / Zinkdruckguss

Furniture knob
▶ Ceramic / steel / zinc die-cast

Bouton de meuble
▶ Céramique / acier / zamak

1 Rot / verchromt
Red / chrome-plated
Rouge / chromé

2 Türkis / verchromt
Turquoise / chrome-plated
Turquoise / chromé

3 Rosa / verchromt
Rose / chrome-plated
Rose / chromé



Nr./No./Ref.	EAN	mm	mm	VE/PU/Qte
1 9 208 229	40080571908177	36	40	1
2 9 208 197	40080571908054	36	40	1
3 9 208 220	40080571908085	36	40	1



Möbelknopf
▶ Mit weißen Punkten
▶ Keramik / Stahl / Zinkdruckguss

Furniture knob
▶ With white dots
▶ Ceramic / steel / zinc die-cast

Bouton de meuble
▶ Avec des pois blancs
▶ Céramique / acier / zamak

1 Türkis / verchromt
Turquoise / chrome-plated
Turquoise / chromé

2 Rosa / verchromt
Rose / chrome-plated
Rose / chromé

3 Rot / verchromt
Red / chrome-plated
Rouge / chromé



Nr./No./Ref.	EAN	mm	mm	VE/PU/Qte
1 9 208 196	40080571908047	36	40	1
2 9 208 218	40080571908061	36	40	1
3 9 208 227	40080571908153	36	40	1



Möbelknopf

- ▶ Mit weißen Streifen
- ▶ Keramik / Stahl / Zinkdruckguss

Furniture knob

- ▶ With white stripes
- ▶ Ceramic / steel / zinc die-cast

Bouton de meuble

- ▶ Avec des rayures blanches
- ▶ Céramique / acier / zamak

- 1 Rosa / verchromt
Rose / chrome-plated
Rose / chromé

- 2 Türkis / verchromt
Turquoise / chrome-plated
Turquoise / chromé

- 3 Rot / verchromt
Red / chrome-plated
Rouge / chromé



Nr./No./Ref.	EAN	mm	mm	VE/PU/Qte
1 9 208 219	40080571908078	36	40	1
2 9 208 231	40080571908191	36	40	1
3 9 208 228	40080571908160	36	40	1



Möbelknopf

- ▶ Keramik / Stahl / Zinkdruckguss

Furniture knob

- ▶ Ceramic / steel / zinc die-cast

Bouton de meuble

- ▶ Céramique / acier / zamak

- 1 Vintage türkis / verchromt
Vintage turquoise / chrome-plated
Vintage turquoise / chromé

- 2 Vintage rot / verchromt
Vintage red / chrome-plated
Vintage rouge / chromé



Nr./No./Ref.	EAN	mm	mm	VE/PU/Qte
1 9 208 238	40080571908269	25	35	1
2 9 208 239	40080571908276	25	35	1



Möbelknopf

- ▶ Vintage Herz
- ▶ Keramik / Stahl

Furniture knob

- ▶ Vintage heart
- ▶ Ceramic / steel

Bouton de meuble

- ▶ Vintage cœur
- ▶ Céramique / acier

- 1 Blau / verchromt
Blue / chrome-plated
Bleu / chromé

- 2 Rosa / verchromt
Rose / chrome-plated
Rose / chromé

- 3 Weiß / verchromt
White / chrome-plated
Blanc / chromé

- 4 Rot / verchromt
Red / chrome-plated
Rouge / chromé



Nr./No./Ref.	EAN	mm	mm	mm	VE/PU/Qte
1 9 208 240	40080571908283	45	38	20	1
2 9 208 243	40080571908313	45	38	20	1
3 9 208 241	40080571908290	45	38	20	1
4 9 208 242	40080571908306	45	38	20	1



Möbelknopf

- ▶ Keramik / Stahl

Furniture knob

- ▶ Ceramic / steel

Bouton de meuble

- ▶ Céramique / acier

- Weiß mit Stern / verchromt
White with star / chrome-plated
Blanc avec étoile / chromé

Nr./No./Ref.	EAN	mm	mm	VE/PU/Qte
9 208 221	40080571908092	25	40	1



Möbelknopf
▶ Keramik / Stahl

Furniture knob
▶ Ceramic / steel

Bouton de meuble
▶ Céramique / acier

Nr./No./Ref.	EAN	mm	mm	VE/PU/Qte
9 208 230	40080571908184	25	40	1

Weiß mit Eule / verchromt
White with owl / chrome-plated
Blanc avec hibou / chromé



Möbelknopf
▶ Keramik / Stahl

Furniture knob
▶ Ceramic / steel

Bouton de meuble
▶ Céramique / acier

Nr./No./Ref.	EAN	mm	mm	VE/PU/Qte
9 208 232	40080571908207	25	40	1

Weiß mit Krone / verchromt
White with crown / chrome-plated
Blanc avec couronne / chromé



Möbelknopf
▶ Keramik / Stahl / Zinkdruckguss

Furniture knob
▶ Ceramic / steel / zinc die-cast

Bouton de meuble
▶ Céramique / acier / zamak

Nr./No./Ref.	EAN	mm	mm	VE/PU/Qte
9 208 234	40080571908221	27	38	1

Ziffernblatt / vermessingt
Clock face / brass-plated
Cadran / laitonné



Möbelknopf
▶ Keramik / Stahl / Zinkdruckguss

Furniture knob
▶ Ceramic / steel / zinc die-cast

Bouton de meuble
▶ Céramique / acier / zamak

Nr./No./Ref.	EAN	mm	mm	VE/PU/Qte
9 208 235	40080571908238	27	38	1

Ziffernblatt / verchromt
Clock face / chrome-plated
Cadran / chromé



Möbelknopf
▶ Keramik / Stahl

Furniture knob
▶ Ceramic / steel

Bouton de meuble
▶ Céramique / acier

Nr./No./Ref.	EAN	mm	mm	VE/PU/Qte
9 208 236	40080571908245	25	40	1

Weiß, schwarz / verchromt
White, black / chrome-plated
Blanc, noir / chromé



Möbelknopf
▶ Keramik / Stahl

Furniture knob
▶ Ceramic / steel

Bouton de meuble
▶ Céramique / acier

Nr./No./Ref.	EAN	mm	mm	VE/PU/Qte
1 9 208 222	40080571908108	25	40	1

Weiß mit Schmetterling / verchromt
White with butterfly / chrome-plated
Blanc avec papillon / chromé



Möbelknopf
▶ Keramik / Stahl

Furniture knob
▶ Ceramic / steel

Bouton de meuble
▶ Céramique / acier

Weiß mit Schmetterling / verchromt
White with butterfly / chrome-plated
Blanc avec papillon / chromé

Nr./No./Ref.	EAN	mm	mm	VE/PU/Qte
9 208 223	40080571908115	25	40	1



Möbelknopf
▶ Keramik / Stahl

Furniture knob
▶ Ceramic / steel

Bouton de meuble
▶ Céramique / acier

Weiß mit Fahrrad / verchromt
White with bicycle / chrome-plated
Blanc avec vélo / chromé

Nr./No./Ref.	EAN	mm	mm	VE/PU/Qte
9 208 224	40080571908122	25	40	1



Möbelknopf
▶ Keramik / Stahl

Furniture knob
▶ Ceramic / steel

Bouton de meuble
▶ Céramique / acier

Weiß mit Fahrrad / verchromt
White with bicycle / chrome-plated
Blanc avec vélo / chromé

Nr./No./Ref.	EAN	mm	mm	VE/PU/Qte
9 208 226	40080571908146	25	40	1



Möbelknopf
▶ Keramik / Stahl

Furniture knob
▶ Ceramic / steel

Bouton de meuble
▶ Céramique / acier

Weiß mit Heißluftballon / verchromt
White with hot air baloon / chrome-plated
Blanc avec montgolfière / chromé

Nr./No./Ref.	EAN	mm	mm	VE/PU/Qte
9 208 225	40080571908139	25	40	1



Möbelknopf
▶ Keramik / Stahl / Zinkdruckguss

Furniture knob
▶ Ceramic / steel / zinc die-cast

Bouton de meuble
▶ Céramique / acier / zamak

Weiß mit Ornament / verchromt
White with ornament / chrome-plated
Blanc avec décoration / chromé

Nr./No./Ref.	EAN	mm	mm	VE/PU/Qte
9 208 233	40080571908214	37	40	1



Möbelknopf
▶ Keramik / Stahl / Zinkdruckguss

Furniture knob
▶ Ceramic / steel / zinc die-cast

Bouton de meuble
▶ Céramique / acier / zamak

Weiß mit Ornament / verchromt
White with ornament / chrome-plated
Blanc avec décoration / chromé

Nr./No./Ref.	EAN	mm	mm	VE/PU/Qte
9 208 195	40080571908030	37	40	1



Blume
Flower
Fleur

Möbelknopf

- ▶ Auch als Garderobenhaken verwendbar
- ▶ Schichtholz

Furniture knob

- ▶ Can also be used as clothes hook
- ▶ Laminated wood

Bouton de meuble

- ▶ Utilisation possible sous forme de crochet de garde-robe
- ▶ Bois lamellé

Nr./No./Ref.	EAN	↔ mm	↕ mm	↗ mm	VE/PU/Qte
9 211 917	4008057035422	55,5	54	28,5	1



Fußball
Football
Football

Möbelknopf

- ▶ Auch als Garderobenhaken verwendbar
- ▶ Schichtholz

Furniture knob

- ▶ Can also be used as clothes hook
- ▶ Laminated wood

Bouton de meuble

- ▶ Utilisation possible sous forme de crochet de garde-robe
- ▶ Bois lamellé

Nr./No./Ref.	EAN	↗ mm	↻ mm	VE/PU/Qte
9 211 928	4008057035439	28,5	56	1



Tiger
Tiger
Tigre

Möbelknopf

- ▶ Auch als Garderobenhaken verwendbar
- ▶ Schichtholz

Furniture knob

- ▶ Can also be used as clothes hook
- ▶ Laminated wood

Bouton de meuble

- ▶ Utilisation possible sous forme de crochet de garde-robe
- ▶ Bois lamellé

Nr./No./Ref.	EAN	↔ mm	↕ mm	↗ mm	VE/PU/Qte
9 211 929	4008057035446	64	50	28,5	1



Marienkäfer
Ladybird
Coccinelle

Möbelknopf

- ▶ Auch als Garderobenhaken verwendbar
- ▶ Schichtholz

Furniture knob

- ▶ Can also be used as clothes hook
- ▶ Laminated wood

Bouton de meuble

- ▶ Utilisation possible sous forme de crochet de garde-robe
- ▶ Bois lamellé

Nr./No./Ref.	EAN	↔ mm	↕ mm	↗ mm	VE/PU/Qte
9 211 930	4008057035453	74	53	28,5	1



Auto
Car
Voiture

Möbelknopf

- ▶ Auch als Garderobenhaken verwendbar
- ▶ Schichtholz

Furniture knob

- ▶ Can also be used as clothes hook
- ▶ Laminated wood

Bouton de meuble

- ▶ Utilisation possible sous forme de crochet de garde-robe
- ▶ Bois lamellé

Nr./No./Ref.	EAN	↔ mm	↕ mm	↗ mm	VE/PU/Qte
9 211 931	4008057035460	66	56	28,5	1



Krokodil
Crocodile
Crocodile

Möbelknopf

- ▶ Elastischer Kunststoff

Furniture knob

- ▶ Elastic plastic

Bouton de meuble

- ▶ Plastique élastique

Nr./No./Ref.	EAN	↔ mm	↕ mm	↗ mm	VE/PU/Qte
9 211 170	4008057034852	54	35	25	1



Fisch
Fish
Poisson

Möbelknopf
▶ Elastischer Kunststoff

Furniture knob
▶ Elastic plastic

Bouton de meuble
▶ Plastique élastique

Nr./No./Ref.	EAN	↔ mm	↕ mm	↗ mm	VE/PU/Qte
9 211 147	4008057034821	54	38	25	1



Blume
Flower
Fleur

Möbelknopf
▶ Elastischer Kunststoff

Furniture knob
▶ Elastic plastic

Bouton de meuble
▶ Plastique élastique

Nr./No./Ref.	EAN	↔ mm	↕ mm	↗ mm	VE/PU/Qte
9 211 168	4008057034838	43	40	25	1



Elefant
Elephant
Éléphant

Möbelknopf
▶ Elastischer Kunststoff

Furniture knob
▶ Elastic plastic

Bouton de meuble
▶ Plastique élastique

Nr./No./Ref.	EAN	↔ mm	↕ mm	↗ mm	VE/PU/Qte
9 211 169	4008057034845	46	37	24	1



Pferd
Horse
Cheval

Möbelknopf
▶ Elastischer Kunststoff

Furniture knob
▶ Elastic plastic

Bouton de meuble
▶ Plastique élastique

Nr./No./Ref.	EAN	↔ mm	↕ mm	↗ mm	VE/PU/Qte
9 211 171	4008057034869	36	45	24	1



Hase
Rabbit
Lièvre

Möbelknopf
▶ Elastischer Kunststoff

Furniture knob
▶ Elastic plastic

Bouton de meuble
▶ Plastique élastique

Nr./No./Ref.	EAN	↔ mm	↕ mm	↗ mm	VE/PU/Qte
9 211 172	4008057034876	46	50	25	1



BUDGET



Einfach und praktisch durch den Alltag. Universell einsetzbare Alleskönner hat die Griff-Kollektion BUDGET zu bieten. Dezente Formen und einfache Materialien lassen solide Möbelstücke wieder wie neu erscheinen.

Getting through everyday life the easy and practical way. The BUDGET handle collection features universal all rounders. Understated shapes and simple materials make substantial pieces of furniture look like new again.

Simple et pratique dans la vie de tous les jours. La collection de poignées BUDGET propose des produits polyvalents utilisables de manière universelle. Des formes sobres et des matériaux simples donnent une seconde vie aux meubles solides.

Möbelgriff

► Zinkdruckguss

Furniture handle

► Zinc die-cast

Poignée de meuble

► Zamak



1 Schwarz verchromt
Black chrome-plated
Chromé noir

2 Edelstahl-Optik
Stainless steel look
Aspect acier affiné

3 Aluminium-Optik
Aluminium look
Aspect aluminium

4 Verchromt
Chrome-plated
Chromé

5 Vermessingt
Brass-plated
Laitonné

6 Vermessingt, brüniert
Brass-plated, burnished
Laitonné, bruni



Nr./No./Ref.	EAN	↔ mm	↔ mm	↕ mm	↗ mm	VE/PU/Qte
1 9 208 468	40080571920186	64	79	10	23	1
1 9 208 457	40080571920179	96	111	10	26,5	1
1 9 208 470	40080571920209	128	144	10	29	1
2 9 202 445	40080571067119	64	79	10	23	1
2 9 202 446	40080571067126	96	111	10	26,5	1
2 9 202 441	40080571067072	128	144	10	29	1
3 9 202 444	40080571067102	64	79	10	23	1
3 9 202 440	40080571067065	96	111	10	26,5	1
3 9 202 443	40080571067096	128	144	10	29	1
4 9 202 442	40080571067089	64	79	10	23	1
4 9 202 439	40080571067058	96	111	10	26,5	1
4 9 202 438	40080571067041	128	144	10	29	1
5 9 202 449	40080571067157	64	79	10	23	1
5 9 202 447	40080571067133	96	111	10	26,5	1
5 9 202 448	40080571067140	128	144	10	29	1
6 9 208 469	40080571920193	64	79	10	23	1
6 9 150 411	40080571013376	96	111	10	26,5	1
6 9 150 429	40080571013383	128	144	10	29	1

Möbelgriff

► Zinkdruckguss

Furniture handle

► Zinc die-cast

Poignée de meuble

► Zamak



1 Aluminium-Optik
Aluminium look
Aspect aluminium

2 Vernickelt
Nickel-plated
Nickelé

3 Schwarz vernickelt
Black nickel-plated
Noir nickelé



Nr./No./Ref.	EAN	↔ mm	↔ mm	↕ mm	↗ mm	VE/PU/Qte
1 9 207 869	40080571907026	96	130	12	27	1
2 9 207 874	40080571907071	96	130	12	27	1
3 9 207 879	40080571907125	96	130	12	27	1

Möbelgriff

- ▶ Zum Aufschrauben
- ▶ Stahl

Furniture handle

- ▶ For screwing on
- ▶ Steel

Poignée de meuble

- ▶ À visser
- ▶ Acier

1 Vermessingt
Brass-plated
Laitonné

2 Vernickelt
Nickel-plated
Nickelé



Nr./No./Ref.	EAN	↔ mm	↕ mm	↗ mm	VE/PU/Qte
1 0 004 048	4008057040488	76	20	21	1
1 0 004 049	4008057040495	100	28	27	1
1 0 004 050	4008057040501	127	32	28	1
1 0 004 051	4008057040518	154	37	28	1
2 0 004 044	4008057040440	76	20	21	1
2 0 004 045	4008057040457	100	28	27	1
2 0 004 046	4008057040464	127	32	28	1
2 0 004 047	4008057040471	154	37	28	1

Kistengriff

- ▶ Zum Aufschrauben
- ▶ Ohne Befestigungsmaterial
- ▶ Stahl

Box handle

- ▶ For screwing on
- ▶ Without fixing material
- ▶ Steel

Poignée de caisse

- ▶ À visser
- ▶ Sans accessoires de fixation
- ▶ Acier

Verzinkt
Zinc-plated
Zingué

Nr./No./Ref.	EAN	↔ mm	↕ mm	↗ mm	VE/PU/Qte
9 100 418	4008057003339	97	62	8	1
9 130 580	40080570905336	97	62	8	10x1

Kistengriff

- ▶ Zum Aufschrauben
- ▶ Ohne Befestigungsmaterial
- ▶ Stahl

Box handle

- ▶ For screwing on
- ▶ Without fixing material
- ▶ Steel

Poignée de caisse

- ▶ À visser
- ▶ Sans accessoires de fixation
- ▶ Acier

Verzinkt
Zinc-plated
Zingué

Nr./No./Ref.	EAN	↔ mm	↔ mm	↕ mm	↗ mm	VE/PU/Qte
9 100 389	4008057002363	130	162	32	16	1
9 130 579	40080570905329	130	162	32	16	10x1

Kistengriff

- ▶ Zum Aufschrauben
- ▶ Ohne Befestigungsmaterial
- ▶ Stahl

Box handles

- ▶ For screwing on
- ▶ Without fixing material
- ▶ Steel

Poignées de caisse

- ▶ À visser
- ▶ Sans accessoires de fixation
- ▶ Acier

Verzinkt
Zinc-plated
Zingué

Nr./No./Ref.	EAN	↔ mm	↕ mm	VE/PU/Qte
9 184 239	4008057027236	85	70	1

Handgriff für Tore

- ▶ Zum Aufschrauben
- ▶ Ohne Befestigungsmaterial
- ▶ Stahl

Handle for gates

- ▶ For screwing on
- ▶ Without fixing material
- ▶ Steel

Poignée pour porte

- ▶ À visser
- ▶ Sans accessoires de fixation
- ▶ Acier

Verzinkt
Zinc-plated
Zingué

Nr./No./Ref.	EAN	↔ mm	↕ mm	VE/PU/Qte
9 202 492	4008057031721	25	210	1



Möbelknopf
▶ Holz

Furniture knob
▶ Wood

Bouton de meuble
▶ Bois

Kiefer, roh
Pine, untreated
Pin, naturel

Nr./No./Ref.	EAN	mm	mm	VE/PU/Qte
0 018 097	4 008 057 1 809 79	27	28	1



Möbelgriff
▶ Kunststoff

Furniture handle
▶ Plastic

Poignée de meuble
▶ Plastique

1 Schwarz
Black
Noir

2 Weiß
White
Blanc

3 Aluminium-Optik
Aluminium look
Aspect aluminium

4 Braun
Brown
Brun



Nr./No./Ref.	EAN	mm	mm	mm	mm	VE/PU/Qte
1 0 004 183	4 008 057 0 418 36	64	73	28	10	1
1 9 203 237	4 008 057 9 063 19	96	105	28	10	1
1 0 004 202	4 008 057 0 420 24	128	138	34,5	10	1
2 0 004 197	4 008 057 0 419 73	64	73	28	10	1
2 9 203 224	4 008 057 9 065 86	96	105	28	10	1
2 0 003 639	4 008 057 0 363 99	128	138	34,5	10	1
3 9 203 259	4 008 057 9 064 18	64	73	28	10	1
3 9 203 260	4 008 057 9 064 25	96	105	28	10	1
3 9 203 244	4 008 057 9 063 88	128	138	34,5	10	1
4 0 004 199	4 008 057 0 419 97	64	73	28	10	1
4 9 203 238	4 008 057 9 063 26	96	105	28	10	1



Möbelgriff
▶ Kunststoff

Furniture handle
▶ Plastic

Poignée de meuble
▶ Plastique

Aluminium-Optik
Aluminium look
Aspect aluminium

Nr./No./Ref.	EAN	mm	mm	mm	mm	VE/PU/Qte
9 203 257	4 008 057 9 063 95	96	140	30	12	1
9 203 243	4 008 057 9 063 71	128	170	30	12	1



Möbelgriff
▶ Kunststoff

Furniture handle
▶ Plastic

Poignée de meuble
▶ Plastique

1 Weiß
White
Blanc

2 Braun
Brown
Brun



Nr./No./Ref.	EAN	mm	mm	mm	mm	VE/PU/Qte
1 9 203 240	4 008 057 9 063 40	96	134	30	12	1
1 9 203 241	4 008 057 9 063 64	128	165	30	12	1
2 9 203 239	4 008 057 9 063 33	96	134	30	12	1
2 9 203 242	4 008 057 9 063 57	128	165	30	12	1



Möbelgriff
▶ Kunststoff

Furniture handle
▶ Plastic

Poignée de meuble
▶ Plastique

Aluminium-Optik
Aluminium look
Aspect aluminium

Nr./No./Ref.	EAN	↔ mm	↔ mm	↕ mm	↗ mm	VE/PU/Qte
9 207 901	40080571907347	96	117	18	28	1
9 207 902	40080571907354	128	148	18	28	1



Möbelknopf
▶ Kunststoff

Furniture knob
▶ Plastic

Bouton de meuble
▶ Plastique

1 Weiß
White
Blanc

Nr./No./Ref.	EAN	↗ mm	↖ mm	VE/PU/Qte
1 9 203 262	40080571906432	29	40	1
2 9 203 298	40080571906449	29	40	1
3 9 203 299	40080571906456	29	40	1

2 Schwarz
Black
Noir



3 Aluminium-Optik
Aluminium look
Aspect aluminium



Möbelknopf
▶ Kunststoff

Furniture knob
▶ Plastic

Bouton de meuble
▶ Plastique

1 Braun
Brown
Brun

Nr./No./Ref.	EAN	↗ mm	↖ mm	VE/PU/Qte
1 9 203 301	40080571906470	31	30	1
2 9 203 300	40080571906463	31	30	1

2 Weiß
White
Blanc



Möbelknopf
▶ Kunststoff

Furniture knob
▶ Plastic

Bouton de meuble
▶ Plastique

1 Aluminium-Optik
Aluminium look
Aspect aluminium

Nr./No./Ref.	EAN	↗ mm	↖ mm	VE/PU/Qte
1 9 203 308	40080571906548	23	25	1
2 9 203 309	40080571906562	23	25	1
3 9 203 453	40080571906593	23	25	1
4 9 203 305	40080571906524	23	25	1
5 9 203 306	40080571906531	23	25	1

2 Silberfarben
Silver coloured
Teinté argent



3 Grau
Grey
Gris



4 Weiß
White
Blanc



5 Schwarz
Black
Noir





Möbelknopf
▶ Kunststoff

Furniture knob
▶ Plastic

Bouton de meuble
▶ Plastique

1 Weiß
White
Blanc

2 Aluminium-Optik
Aluminium look
Aspect aluminium

3 Grau
Grey
Gris



Nr./No./Ref.	EAN	mm	mm	VE/PU/Qte
1 9 203 302	40080571906487	27	33	1
2 9 203 303	40080571906579	27	33	1
3 9 203 304	40080571906517	27	33	1



Möbelknopf
▶ Kunststoff

Furniture knob
▶ Plastic

Bouton de meuble
▶ Plastique

Aluminium-Optik
Aluminium look
Aspect aluminium

Nr./No./Ref.	EAN	mm	mm	mm	VE/PU/Qte
9 203 310	40080571906494	15	15	25	1



Möbelknopf
▶ Kunststoff

Furniture knob
▶ Plastic

Bouton de meuble
▶ Plastique

Aluminium-Optik
Aluminium look
Aspect aluminium

Nr./No./Ref.	EAN	mm	mm	VE/PU/Qte
9 203 311	40080571906500	24	15	1



Möbelknopf
▶ Kunststoff

Furniture knob
▶ Plastic

Bouton de meuble
▶ Plastique

Weiß / goldfarben
White / gold coloured
Blanc / teinte dorée

Nr./No./Ref.	EAN	mm	mm	VE/PU/Qte
9 207 903	40080571907361	27,5	36,5	1



Einlassgriff
▶ Kunststoff

Recessed handle
▶ Plastic

Poignée encastrée insert
▶ Plastique

1 Schwarz
Black
Noir

2 Weiß
White
Blanc



Nr./No./Ref.	EAN	mm	mm	mm	VE/PU/Qte
1 9 126 436	40080571009584	8,5	35	40	2
2 9 126 437	40080571009591	8,5	35	40	2



Einlassgriff
▶ Kunststoff

Recessed handle
▶ Plastic

Poignée encastrée insert
▶ Plastique

Nr./No./Ref.	EAN	mm	mm	mm	VE/PU/Qte
1 9 211 303	4008057035132	13	50	53,5	1
2 9 211 315	4008057035149	13	50	53,5	1
3 9 211 317	4008057035156	13	50	53,5	1



Einlassgriff
▶ Kunststoff

Recessed handle
▶ Plastic

Poignée encastrée insert
▶ Plastique

Nr./No./Ref.	EAN	mm	mm	mm	VE/PU/Qte
1 9 211 320	4008057035163	88,5 / 78,5	30,5 / 22,5	11	1
2 9 211 321	4008057035170	88,5 / 78,5	30,5 / 22,5	11	1

Zubehör Accessories Accessoires



Schraube
▶ Für Montage von Möbelgriffen und -knöpfen
▶ PZ-Kreuzschlitz
▶ Stahl

Screw
▶ For mounting furniture handles and knobs
▶ Pozidrive screw
▶ Steel

Vis
▶ Pour le montage de poignées et de boutons de meuble
▶ Empreinte cruciforme PZ
▶ Acier

Nr./No./Ref.	EAN	mm	mm	VE/PU/Qte
0 007 600	4008057076005	25	M4	10
0 007 601	4008057076012	45	M4	10
0 007 602	4008057076029	52	M4	10

Verzinkt
Zinc-plated
Zingué

Garderoben & Haken
Clothes rails & hooks
Garde-robres & crochets

Unser Verkaufsregal: Garderoben & Haken
Our retail display: clothes rails & hooks
Notre rayon: garde-robres & crochets



Zubehör

Accessories

Accessoires

Kein Platz an der Wand?

Machen Sie aus Ihrer Garderobenleiste eine Türhängegarderobe! Einfach die Türaufhängung auf die Rückseite der Garderobenleiste schrauben und an die Tür hängen.

No space by the wall?

Turn your clothes rail into a door hanger! Simply screw the door hanger to the back of the clothes rail and hang it over the top of the door.

Plus de place au mur ?

Transformez votre patère en garde-robe à accrocher à la porte ! Il suffit de visser la fixation pour la porte située au dos de la patère et de l'accrocher à la porte.

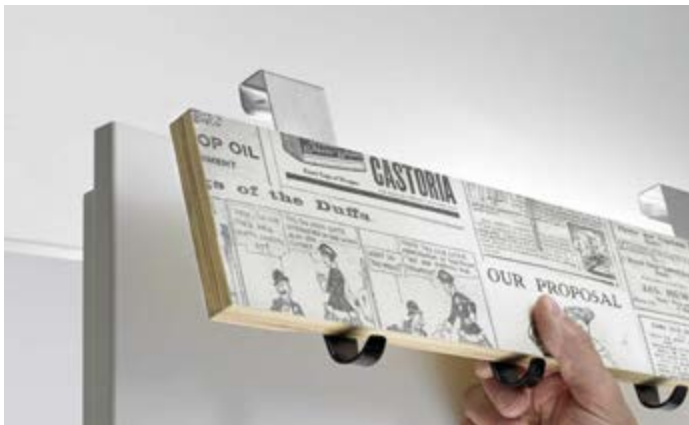

Erweiterbare Garderobenleisten sind im Artikelteil markiert.

Upgradable clothes rail are marked in the article section.

Des crochet pour chapeau et manteau extensibles sont marquées dans la section réservée à l'article.



Türaufhängung für Garderobenleisten

- ▶ Zum Anschrauben
- ▶ Ohne Befestigungsmaterial
- ▶ Edelstahl

Achtung! Bitte Schraubenlänge beachten!

Door hanger for clothes rail

- ▶ For screwing on
- ▶ Without fixing material
- ▶ Stainless steel

Attention! Please bear in mind the length of screws.

Fixation de la porte pour les crochet pour chapeau et manteau

- ▶ À visser
- ▶ Sans accessoires de fixation
- ▶ Acier affiné

Attention! Veuillez tenir compte de la longueur des vis !

Seidenmatt
Silky matt
Satiné

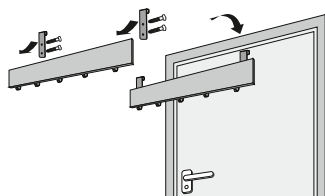

Nr./No./Ref.	EAN	mm	mm	mm	mm	VE/PU/Qte
9 220 838	4008057038614	16	40	133	20	1

Modern

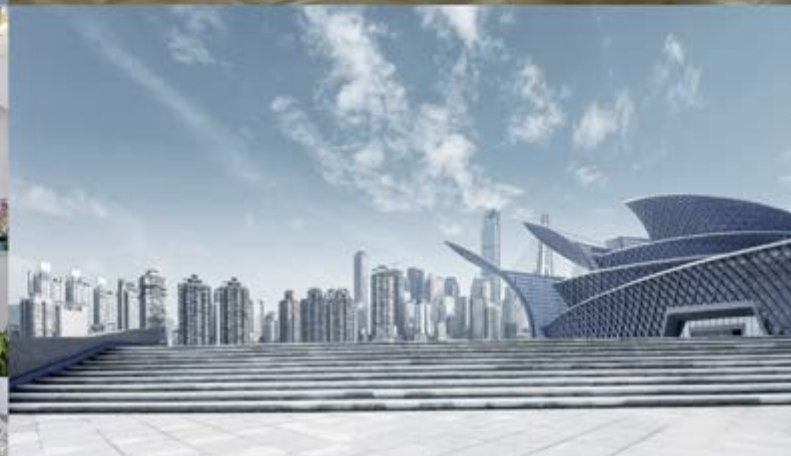

Technik, Transparenz und sachliche Strukturen bestimmen das moderne Leben und Wohnen. Futuristisches Design und eine klare, reduzierte Formgebung machen die Kollektion MODERN unverwechselbar. Die Formen folgen dabei den technischen Möglichkeiten ihrer Herstellung und setzt reizvolle optische Akzente.

Technology, transparency and linear structures define modern life and the home environment. Futuristic design and a clear-cut, reduced style give the MODERN collection an unmistakable look. Its shapes result from the technical means of producing them and create a visual fascination.

La technique, la transparence et les structures neutres caractérisent la vie et l'habitat modernes. Un design futuriste et des formes réduites très claires rendent la collection MODERN unique au monde. Les formes épousent les possibilités techniques de sa fabrication et créent des accents optiques charmants.



Lackiert
Laquered
Laqué

Memoboard

- ▶ Mit Kreide beschreibbar
- ▶ 3 Haken
- ▶ 1 Ablage, 100 x 35 mm
- ▶ Holz

Memo board

- ▶ Suitable for writing on with chalk
- ▶ 3 hooks
- ▶ 1 shelf, 100 x 35 mm
- ▶ Wood

Aide-mémoire

- ▶ Possibilité d'écrire à la craie
- ▶ 3 crochets
- ▶ 1 étagère, 100 x 35 mm
- ▶ Bois

Nr./No./Ref.	EAN	↔ mm	↕ mm	↗ mm	VE/PU/Qte
9 220 848	4008057038706	350	300	35	1



Anthrazit
Anthracite
Anthracite

Schlüsselbrett / Memoboard

- ▶ 3 Haken
- ▶ 1 Ablage, 180 x 20 mm
- ▶ Stahl

Key holder / Memo board

- ▶ 3 hooks
- ▶ 1 shelf, 180 x 20 mm
- ▶ Steel

Tableau à clés / aide-mémoire

- ▶ 3 crochets
- ▶ 1 étagère, 180 x 20 mm
- ▶ Acier

Nr./No./Ref.	EAN	↔ mm	↕ mm	↗ mm	VE/PU/Qte
9 220 846	4008057038690	180	450	32	1



Seidenmatt
Silky matt
Satiné

Garderobe

- ▶ 3 Haken
- ▶ Edelstahl



Clothes rail

- ▶ 3 hooks
- ▶ Stainless steel

Garde-robe

- ▶ 3 crochets
- ▶ Acier affiné

Nr./No./Ref.	EAN	↔ mm	↕ mm	↗ mm	VE/PU/Qte
9 101 751	4008057000666	255	140	50	1



Seidenmatt
Silky matt
Satiné

Garderobe

- ▶ 4 Haken
- ▶ Edelstahl



Clothes rail

- ▶ 4 hooks
- ▶ Stainless steel

Garde-robe

- ▶ 4 crochets
- ▶ Acier affiné

Nr./No./Ref.	EAN	↔ mm	↕ mm	↗ mm	VE/PU/Qte
9 101 752	4008057000673	355	140	50	1



Seidenmatt
Silky matt
Satiné

Garderobe

- ▶ 3 Haken
- ▶ Edelstahl



Clothes rail

- ▶ 3 hooks
- ▶ Stainless steel

Garde-robe

- ▶ 3 crochets
- ▶ Acier affiné

Nr./No./Ref.	EAN	↔ mm	↕ mm	↗ mm	VE/PU/Qte
9 101 754	4008057000697	255	85	45	1



Seidenmatt
Silky matt
Satiné

Garderobe

- ▶ 4 Haken
- ▶ Edelstahl



Clothes rail

- ▶ 4 hooks
- ▶ Stainless steel

Garde-robe

- ▶ 4 crochets
- ▶ Acier affiné

Nr./No./Ref.	EAN	↔ mm	↕ mm	↗ mm	VE/PU/Qte
9 101 755	4008057000703	355	85	45	1



Garderobe
 ▶ 3 Haken
 ▶ Edelstahl

Clothes rail
 ▶ 3 hooks
 ▶ Stainless steel

Garde-robe
 ▶ 3 crochets
 ▶ Acier affiné

Seidenmatt
 Silky matt
 Satiné



Nr./No./Ref.	EAN	↔ mm	↕ mm	↗ mm	VE/PU/Qte
9 101 756		220	85	55	1



Garderobe
 ▶ 5 Haken
 ▶ Edelstahl

Clothes rail
 ▶ 5 hooks
 ▶ Stainless steel

Garde-robe
 ▶ 5 crochets
 ▶ Acier affiné

Seidenmatt
 Silky matt
 Satiné



Nr./No./Ref.	EAN	↔ mm	↕ mm	↗ mm	VE/PU/Qte
9 101 757		380	85	55	1



Garderobe
 ▶ 4 Haken
 ▶ Edelstahl

Clothes rail
 ▶ 4 hooks
 ▶ Stainless steel

Garde-robe
 ▶ 4 crochets
 ▶ Acier affiné

Seidenmatt
 Silky matt
 Satiné



Nr./No./Ref.	EAN	↔ mm	↕ mm	↗ mm	VE/PU/Qte
9 101 760		355	160	60	1

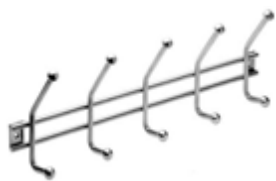

Garderobe
 ▶ 5 Haken
 ▶ Edelstahl

Clothes rail
 ▶ 5 hooks
 ▶ Stainless steel

Garde-robe
 ▶ 5 crochets
 ▶ Acier affiné

Seidenmatt
 Silky matt
 Satiné



Nr./No./Ref.	EAN	↔ mm	↕ mm	↗ mm	VE/PU/Qte
9 101 761		452	160	60	1



Garderobe
 ▶ 3 Haken
 ▶ Edelstahl

Clothes rail
 ▶ 3 hooks
 ▶ Stainless steel

Garde-robe
 ▶ 3 crochets
 ▶ Acier affiné

Seidenmatt
 Silky matt
 Satiné



Nr./No./Ref.	EAN	↔ mm	↕ mm	↗ mm	VE/PU/Qte
9 101 762		255	155	50	1



Garderobe
 ▶ 4 Haken
 ▶ Edelstahl

Clothes rail
 ▶ 4 hooks
 ▶ Stainless steel

Garde-robe
 ▶ 4 crochets
 ▶ Acier affiné

Seidenmatt
 Silky matt
 Satiné



Nr./No./Ref.	EAN	↔ mm	↕ mm	↗ mm	VE/PU/Qte
9 101 763		355	155	50	1



Seidenmatt
Silky matt
Satiné

Garderobe
▶ 2 Haken
▶ Edelstahl



Clothes rail
▶ 2 Hook
▶ Stainless steel

Garde-robe
▶ 2 Crochet
▶ Acier affiné

Nr./No./Ref.	EAN	↔ mm	↕ mm	↗ mm	VE/PU/Qte
0 060 504	4 008057 605043	140	165	55	1



Seidenmatt
Silky matt
Satiné

Garderobe
▶ 3 Haken
▶ Edelstahl



Clothes rail
▶ 3 hooks
▶ Stainless steel

Garde-robe
▶ 3 crochets
▶ Acier affiné

Nr./No./Ref.	EAN	↔ mm	↕ mm	↗ mm	VE/PU/Qte
0 060 503	4 008057 605038	220	165	55	1



Seidenmatt
Silky matt
Satiné

Garderobe
▶ 4 Haken
▶ Edelstahl



Clothes rail
▶ 4 hooks
▶ Stainless steel

Garde-robe
▶ 4 crochets
▶ Acier affiné

Nr./No./Ref.	EAN	↔ mm	↕ mm	↗ mm	VE/PU/Qte
0 060 502	4 008057 605021	300	165	55	1



Seidenmatt
Silky matt
Satiné

Mantelhaken
▶ Edelstahl



Coat hook
▶ Stainless steel

Crochet pour manteau
▶ Acier affiné

Nr./No./Ref.	EAN	↔ mm	↕ mm	↗ mm	VE/PU/Qte
0 060 507	4 008057 605076	42	42	36	1



Seidenmatt
Silky matt
Satiné

Hakenleiste
▶ 2 Haken
▶ Edelstahl



Hook rack
▶ 2 Hook
▶ Stainless steel

Barre à crochets
▶ 2 Crochet
▶ Acier affiné

Nr./No./Ref.	EAN	↔ mm	↕ mm	↗ mm	VE/PU/Qte
0 060 506	4 008057 605069	140	35	36	1



Seidenmatt
Silky matt
Satiné

Hakenleiste
▶ 3 Haken
▶ Edelstahl



Hook rack
▶ 3 hooks
▶ Stainless steel

Barre à crochets
▶ 3 crochets
▶ Acier affiné

Nr./No./Ref.	EAN	↔ mm	↕ mm	↗ mm	VE/PU/Qte
0 060 505	4 008057 605052	220	35	36	1



Hakenleiste
 ▶ 3 Haken
 ▶ Edelstahl

Hook rack
 ▶ 3 hooks
 ▶ Stainless steel

Barre à crochets
 ▶ 3 crochets
 ▶ Acier affiné

Seidenmatt
 Silky matt
 Satiné



Nr./No./Ref.	EAN	↔ mm	↕ mm	↗ mm	VE/PU/Qte
9 101 758	4 008 057 000734	270	35	35	1



Hakenleiste
 ▶ 4 Haken
 ▶ Edelstahl

Hook rack
 ▶ 4 hooks
 ▶ Stainless steel

Barre à crochets
 ▶ 4 crochets
 ▶ Acier affiné

Seidenmatt
 Silky matt
 Satiné



Nr./No./Ref.	EAN	↔ mm	↕ mm	↗ mm	VE/PU/Qte
9 101 759	4 008 057 000741	370	35	35	1



Hakenleiste
 ▶ 3 Haken
 ▶ Aluminium / Zinkdruckguss

Hook rack
 ▶ 3 hooks
 ▶ Aluminium / zinc die-cast

Barre à crochets
 ▶ 3 crochets
 ▶ Aluminium / zamak

Eloxiert / verchromt
 Anodised / chrome-plated
 Anodisé / chromé

Nr./No./Ref.	EAN	↔ mm	↕ mm	↗ mm	VE/PU/Qte
0 047 156	4 008 057 471565	315	110	80	1



Hakenleiste
 ▶ 4 Haken
 ▶ Aluminium / Zinkdruckguss

Hook rack
 ▶ 4 hooks
 ▶ Aluminium / zinc die-cast

Barre à crochets
 ▶ 4 crochets
 ▶ Aluminium / zamak

Eloxiert / verchromt
 Anodised / chrome-plated
 Anodisé / chromé

Nr./No./Ref.	EAN	↔ mm	↕ mm	↗ mm	VE/PU/Qte
0 047 155	4 008 057 471558	435	110	80	1

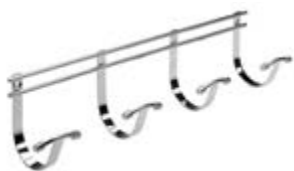

Garderobenleiste
 ▶ 4 Haken
 ▶ Stahl

Clothes rail
 ▶ 4 hooks
 ▶ Steel

Patère
 ▶ 4 crochets
 ▶ Acier

Verchromt
 Chrome-plated
 Chromé

Nr./No./Ref.	EAN	↔ mm	↕ mm	↗ mm	VE/PU/Qte
0 049 827	4 008 057 498272	490	110	92	1



Haken zum Auffächern
 ▶ 3 Haken
 ▶ Zinkdruckguss

Hooks for fanning out
 ▶ 3 hooks
 ▶ Zinc die-cast

Crochet à têtes pivotantes
 ▶ 3 crochets
 ▶ Zamak

Edelstahl-Optik
 Stainless steel look
 Aspect acier affiné

Nr./No./Ref.	EAN	↔ mm	↕ mm	↗ mm	VE/PU/Qte
9 217 258	4 008 057 907699	100	88	88	1



Hakenleiste

- ▶ 3 Haken
- ▶ Zinkdruckguss

Hook rack

- ▶ 3 hooks
- ▶ Zinc die-cast

Barre à crochets

- ▶ 3 crochets
- ▶ Zamak

Aluminium-Optik
Aluminium look
Aspect aluminium

Nr./No./Ref.	EAN	↔ mm	↕ mm	↗ mm	VE/PU/Qte
9 207 980		215	62	45	1



Hakenleiste

- ▶ 4 Haken
- ▶ Zinkdruckguss

Hook rack

- ▶ 4 hooks
- ▶ Zinc die-cast

Barre à crochets

- ▶ 4 crochets
- ▶ Zamak

Aluminium-Optik
Aluminium look
Aspect aluminium

Nr./No./Ref.	EAN	↔ mm	↕ mm	↗ mm	VE/PU/Qte
9 207 979		293	62	45	1



Hakenleiste

- ▶ 5 Haken
- ▶ Zinkdruckguss

Hook rack

- ▶ 5 hooks
- ▶ Zinc die-cast

Barre à crochets

- ▶ 5 crochets
- ▶ Zamak

Aluminium-Optik
Aluminium look
Aspect aluminium

Nr./No./Ref.	EAN	↔ mm	↕ mm	↗ mm	VE/PU/Qte
9 207 978		370	62	45	1



Hakenleiste

- ▶ 3 Doppelhaken
- ▶ Edelstahl / Zinkdruckguss

Hook rack

- ▶ 3 double hooks
- ▶ Stainless steel / zinc die-cast

Barre à crochets

- ▶ 3 crochets doubles
- ▶ Acier affiné / zamak

Verchromt
Chrome-plated
Chromé



Nr./No./Ref.	EAN	↔ mm	↕ mm	↗ mm	VE/PU/Qte
0 040 015		280	38	33	1



Hakenleiste

- ▶ 4 Doppelhaken
- ▶ Edelstahl / Zinkdruckguss

Hook rack

- ▶ 4 double hooks
- ▶ Stainless steel / zinc die-cast

Barre à crochets

- ▶ 4 crochets doubles
- ▶ Acier affiné / zamak

Verchromt
Chrome-plated
Chromé



Nr./No./Ref.	EAN	↔ mm	↕ mm	↗ mm	VE/PU/Qte
0 040 014		380	38	33	1



Hakenleiste

- ▶ 5 Doppelhaken
- ▶ Edelstahl / Zinkdruckguss

Hook rack

- ▶ 5 double hooks
- ▶ Stainless steel / zinc die-cast

Barre à crochets

- ▶ 5 crochets doubles
- ▶ Acier affiné / zamak

Verchromt
Chrome-plated
Chromé



Nr./No./Ref.	EAN	↔ mm	↕ mm	↗ mm	VE/PU/Qte
0 040 013		485	38	33	1



Mantelhaken
▶ Zinkdruckguss

Coat hook
▶ Zinc die-cast

Crochet pour manteau
▶ Zamak

1 Edelstahl-Optik
Stainless steel look
Aspect acier affiné

2 Aluminium-Optik
Aluminium look
Aspect aluminium

3 Silberfarben, brüniert
Silver coloured, burnished
Teinté argent, bruni



Nr./No./Ref.	EAN	↔ mm	↕ mm	↗ mm	VE/PU/Qte
1 9 196 444	4008057065924	60	70	20	1
2 9 196 449	4008057065931	60	70	20	1
3 9 196 450	4008057065948	60	70	20	1



Mantelhaken zum Klappen
▶ Zinkdruckguss

Folding coat hook
▶ Zinc die-cast

Crochet pour manteau à rabattre
▶ Zamak

1 Edelstahl-Optik
Stainless steel look
Aspect acier affiné

2 Aluminium-Optik
Aluminium look
Aspect aluminium



Nr./No./Ref.	EAN	↔ mm	↕ mm	↗ mm	VE/PU/Qte
1 0 040 002	4008057400022	33	70	61	1
2 0 040 001	4008057400015	33	70	61	1



Mantelhaken
▶ Zinkdruckguss

Coat hook
▶ Zinc die-cast

Crochet pour manteau
▶ Zamak

Edelstahl-Optik
Stainless steel look
Aspect acier affiné

Nr./No./Ref.	EAN	↔ mm	↕ mm	↗ mm	VE/PU/Qte
9 207 904	4008057907378	20	64	60	1



Mantelhaken
▶ Zinkdruckguss

Coat hook
▶ Zinc die-cast

Crochet pour manteau
▶ Zamak

1 Aluminium-Optik
Aluminium look
Aspect aluminium

2 Edelstahl-Optik
Stainless steel look
Aspect acier affiné



Nr./No./Ref.	EAN	↔ mm	↕ mm	↗ mm	VE/PU/Qte
1 9 207 940	4008057907620	20	130	59	1
2 9 207 942	4008057907644	20	130	59	1



Hut- und Mantelhaken
▶ Zinkdruckguss

Hat and coat hook
▶ Zinc die-cast

Crochet pour chapeau et manteau
▶ Zamak

1 Edelstahl-Optik
Stainless steel look
Aspect acier affiné

Nr./No./Ref.	EAN	↔ mm	↕ mm	↗ mm	VE/PU/Qte
1 9 207 949	4008057907712	25	155	65	1
2 9 207 946	4008057907682	25	155	65	1

2 Aluminium-Optik
Aluminium look
Aspect aluminium



Mantelhaken
▶ Stahl

Coat hook
▶ Steel

Crochet pour manteau
▶ Acier

Edelstahl-Optik
Stainless steel look
Aspect acier affiné

Nr./No./Ref.	EAN	↔ mm	↕ mm	↗ mm	VE/PU/Qte
0 014 175	4008057141758	20	73	42	1



Mantelhaken
▶ Edelstahl

Coat hook
▶ Stainless steel

Crochet pour manteau
▶ Acier affiné

Seidenmatt
Silky matt
Satiné



Nr./No./Ref.	EAN	↔ mm	↕ mm	↗ mm	VE/PU/Qte
0 014 178	4008057141789	45	58	59	1



Hut- und Mantelhaken
▶ Stahl

Hat and coat hook
▶ Steel

Crochet pour chapeau et manteau
▶ Acier

Aluminium-Optik
Aluminium look
Aspect aluminium

Nr./No./Ref.	EAN	↔ mm	↕ mm	↗ mm	VE/PU/Qte
0 005 642	4008057056427	22	128	61	1



Hut- und Mantelhaken
▶ Zinkdruckguss

Hat and coat hook
▶ Zinc die-cast

Crochet pour chapeau et manteau
▶ Zamak

Aluminium-Optik
Aluminium look
Aspect aluminium

Nr./No./Ref.	EAN	↔ mm	↕ mm	↗ mm	VE/PU/Qte
0 014 120	4008057141208	24	90	63	1



Aluminium-Optik
Aluminium look
Aspect aluminium

Hut- und Mantelhaken
▶ Zinkdruckguss

Hat and coat hook
▶ Zinc die-cast

Crochet pour chapeau et manteau
▶ Zamak

Nr./No./Ref.	EAN	↔ mm	↕ mm	↗ mm	VE/PU/Qte
0 040 003	4 008 057 400039	25	90	58	1



Aluminium-Optik
Aluminium look
Aspect aluminium

Hut- und Mantelhaken
▶ Zinkdruckguss

Hat and coat hook
▶ Zinc die-cast

Crochet pour chapeau et manteau
▶ Zamak

Nr./No./Ref.	EAN	↔ mm	↕ mm	↗ mm	VE/PU/Qte
0 014 130	4 008 057 141307	70	110	66	1



Aluminium-Optik
Aluminium look
Aspect aluminium

Hut- und Mantelhaken
▶ Zinkdruckguss

Hat and coat hook
▶ Zinc die-cast

Crochet pour chapeau et manteau
▶ Zamak

Nr./No./Ref.	EAN	↔ mm	↕ mm	↗ mm	VE/PU/Qte
0 014 131	4 008 057 141314	77	68	35	1



Vernickelt
Nickel-plated
Nickelé

Mantelhaken
▶ Zinkdruckguss

Coat hook
▶ Zinc die-cast

Crochet pour manteau
▶ Zamak

Nr./No./Ref.	EAN	↔ mm	↕ mm	↗ mm	VE/PU/Qte
9 207 921	4 008 057 907538	25	69	23	1



Vernickelt
Nickel-plated
Nickelé

Mantelhaken
▶ Zinkdruckguss

Coat hook
▶ Zinc die-cast

Crochet pour manteau
▶ Zamak

Nr./No./Ref.	EAN	↔ mm	↕ mm	↗ mm	VE/PU/Qte
9 207 910	4 008 057 907439	25	117	48	1



Seidenmatt
Silky matt
Satiné

Hut- und Mantelhaken
▶ Edelstahl

Hat and coat hook
▶ Stainless steel

Crochet pour chapeau et manteau
▶ Acier affiné

Nr./No./Ref.	EAN	↔ mm	↕ mm	↗ mm	VE/PU/Qte
0 014 173	4 008 057 141734	32	45	50	1





Haken

- ▶ Selbstklebend
- ▶ Stahl

Hook

- ▶ Self adhesive
- ▶ Steel

Crochet

- ▶ Auto adhésif
- ▶ Acier

Edelstahl-Optik
Stainless steel look
Aspect acier affiné

Nr./No./Ref.	EAN	↔ mm	↕ mm	↗ mm	VE/PU/Qte
9 211 932	4008057035477	35	39	20	1



Hakenleiste

- ▶ Selbstklebend
- ▶ 3 Haken
- ▶ Stahl

Hook rack

- ▶ Self adhesive
- ▶ 3 hooks
- ▶ Steel

Barre à crochets

- ▶ Auto adhésif
- ▶ 3 crochets
- ▶ Acier

Edelstahl-Optik
Stainless steel look
Aspect acier affiné

Nr./No./Ref.	EAN	↔ mm	↕ mm	↗ mm	VE/PU/Qte
9 211 934	4008057035484	120	28	20	1



Hakenleiste

- ▶ Selbstklebend
- ▶ 4 Haken
- ▶ Stahl

Hook rack

- ▶ Self adhesive
- ▶ 4 hooks
- ▶ Steel

Barre à crochets

- ▶ Auto adhésif
- ▶ 4 crochets
- ▶ Acier

Edelstahl-Optik
Stainless steel look
Aspect acier affiné

Nr./No./Ref.	EAN	↔ mm	↕ mm	↗ mm	VE/PU/Qte
9 211 935	4008057035491	160	28	20	1



Türhängehaken

- ▶ Edelstahl

Door hanger hook

- ▶ Stainless steel

Crochet à accrocher à la porte

- ▶ Acier affiné

Seidenmatt
Silky matt
Satiné



Nr./No./Ref.	EAN	mm	↔ mm	↕ mm	↗ mm	VE/PU/Qte
9 084 189	40080570856614	16	40	133	54	1



Türhängegarderobe

- ▶ 4 Haken
- ▶ Edelstahl

Door hanger clothes rail

- ▶ 4 hooks
- ▶ Stainless steel

Garde-robe à accrocher à la porte

- ▶ 4 crochets
- ▶ Acier affiné

Seidenmatt
Silky matt
Satiné



Nr./No./Ref.	EAN	mm	↔ mm	↕ mm	↗ mm	VE/PU/Qte
9 084 191	40080570856638	16	400	135	60	1



Türhängehaken
▶ Edelstahl

Door hanger hook
▶ Stainless steel

Crochet à accrocher à la porte
▶ Acier affiné

Seidenmatt
Silky matt
Satiné



Nr./No./Ref.	EAN	mm	mm	mm	mm	VE/PU/Qte
9 084 192	4 008 057 856645	16	40	133	20	1



Türhängegarderobe
▶ 4 Haken
▶ Edelstahl

Door hanger clothes rail
▶ 4 hooks
▶ Stainless steel

Garde-robe à accrocher à la porte
▶ 4 crochets
▶ Acier affiné

Seidenmatt
Silky matt
Satiné



Nr./No./Ref.	EAN	mm	mm	mm	mm	VE/PU/Qte
9 084 144	4 008 057 856591	16	400	135	60	1

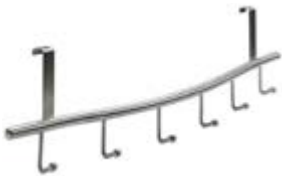

Türhängegarderobe
▶ 6 Haken
▶ Edelstahl

Door hanger clothes rail
▶ 6 hooks
▶ Stainless steel

Garde-robe à accrocher à la porte
▶ 6 crochets
▶ Acier affiné

Seidenmatt
Silky matt
Satiné



Nr./No./Ref.	EAN	mm	mm	mm	mm	VE/PU/Qte
0 060 501	4 008 057 605014	20	595	170	90	1



Antik & Retro



Beständigkeit vermittelt Geborgenheit. Traditionelle Formen und Farben sowie üppige Muster bereichern den Alltag der modernen Sachlichkeit. Das Design der Kollektion ANTIK & RETRO greift gekonnt den bunten Stil- und Materialmix des Retrostyles auf. Auffallend anders und ausdrucksstark in Form, Oberfläche und Material unterstreichen die Garderoben und Haken im Wohnraum den individuellen Charakter seiner Bewohner.

Consistency conveys a sense of homely warmth and comfort. Traditional shapes and colours as well as opulent patterns enrich everyday routine in the world of modern practicality. The design of the ANTIK & RETRO handle collection skilfully picks up on the colourful combination of styles and materials of the retro style.

La constance suscite la sécurité. Des formes et des couleurs traditionnelles ainsi que des motifs exubérants enrichissent le quotidien de la sobriété moderne. Le design de la collection ANTIK et RETRO reprend l'alliance très colorée des styles et des matériaux du style rétro.



1 Lackiert / schwarz
Laquered / black
Laqué / noir



Motivgarderobe „Zeitung“

- ▶ 4 Haken, schwarz
- ▶ Holz / Zinkdruckguss
- ▶ Erweiterbar zur Türhängegarderobe mit Art. 9220838, Seite 71

„Newspaper“ motif clothes rail

- ▶ 4 hooks, black
- ▶ Wood / zinc die-cast
- ▶ Can be turned into a door hanger clothes rail with art. no. 9220838, page 71

Garde-robe motif « Journal »

- ▶ 4 crochets, noir
- ▶ Bois / zamak
- ▶ Extension possible pour former une garde-robe à accrocher à la porte avec la réf. 9220838, page 71

Nr./No./Ref.	EAN	↔ mm	↕ mm	↗ mm	VE/PU/Qte
9 220 845	4 008 057 038683	500	100	25	1



1 Lackiert / weiß
Laquered / white
Laqué / blanc



Motivgarderobe „Coffee shop“

- ▶ 4 Haken, weiß
- ▶ Holz / Zinkdruckguss
- ▶ Erweiterbar zur Türhängegarderobe mit Art. 9220838, Seite 71

„Coffee shop“ motif clothes rail

- ▶ 4 hooks, white
- ▶ Wood / zinc die-cast
- ▶ Can be turned into a door hanger clothes rail with art. no. 9220838, page 71

Garde-robe motif « Coffee shop »

- ▶ 4 crochets, blanc
- ▶ Bois / zamak
- ▶ Extension possible pour former une garde-robe à accrocher à la porte avec la réf. 9220838, page 71

Nr./No./Ref.	EAN	↔ mm	↕ mm	↗ mm	VE/PU/Qte
9 220 842	4 008 057 038652	500	250	25	1



1 Lackiert / vernickelt
Laquered / nickel-plated
Laqué / nickelé



Motivgarderobe „Ornamente“

- ▶ 5 Haken, vernickelt
- ▶ Holz / Zinkdruckguss
- ▶ Erweiterbar zur Türhängegarderobe mit Art. 9220838, Seite 71

„Ornaments“ motif clothes rail

- ▶ 5 hooks, nickel-plated
- ▶ Wood / zinc die-cast
- ▶ Can be turned into a door hanger clothes rail with art. no. 9220838, page 71

Garde-robe motif « Décorations »

- ▶ 5 crochets, nickelé
- ▶ Bois / zamak
- ▶ Extension possible pour former une garde-robe à accrocher à la porte avec la réf. 9220838, page 71

Nr./No./Ref.	EAN	↔ mm	↕ mm	↗ mm	VE/PU/Qte
9 220 840	4 008 057 038638	750	100	25	1



1 Silberfarben, brüniert
Silver coloured, burnished
Teinté argent, bruni

2 Vermessingt, brüniert
Brass-plated, burnished
Laitonné, bruni

3 Vermessingt, poliert
Brass-plated, polished
Laitonné, poli



Mantelhaken

- ▶ Zinkdruckguss

Coat hook

- ▶ Zinc die-cast

Crochet pour manteau

- ▶ Zamak

Nr./No./Ref.	EAN	↔ mm	↕ mm	↗ mm	VE/PU/Qte
1 0 004 879	4 008 057 048798	54	63	19	1
2 0 004 869	4 008 057 048699	54	63	19	1
3 0 004 855	4 008 057 048552	54	63	19	1



1 Vermessingt, brüniert
Brass-plated, burnished
Laitonné, bruni

2 Vermessingt, poliert
Brass-plated, polished
Laitonné, poli



Hut- und Mantelhaken

- ▶ Zinkdruckguss

Hat and coat hook

- ▶ Zinc die-cast

Crochet pour chapeau et manteau

- ▶ Zamak

Nr./No./Ref.	EAN	↔ mm	↕ mm	↗ mm	VE/PU/Qte
1 0 004 868	4 008 057 048682	54	157	65	1
2 0 004 854	4 008 057 048543	54	157	65	1



Mantelhaken
▶ Zinkdruckguss

Coat hook
▶ Zinc die-cast

Crochet pour manteau
▶ Zamak

- 1 Silberfarben, brüniert
Silver coloured, burnished
Teinté argent, bruni
- 2 Vermessingt, brüniert, glänzend
Brass-plated, burnished, gloss
Laitonné, bruni, brillant
- 3 Vermessingt, brüniert
Brass-plated, burnished
Laitonné, bruni
- 4 Aluminium-Optik
Aluminium look
Aspect aluminium



Nr./No./Ref.	EAN	↔ mm	↕ mm	↗ mm	VE/PU/Qte
1 9 207 975	40080571907910	68	76	45	1
2 9 207 976	40080571907927	68	76	45	1
3 9 207 973	40080571907897	68	76	45	1
4 9 207 974	40080571907903	68	76	45	1



Hut- und Mantelhaken
▶ Zinkdruckguss

Hat and coat hook
▶ Zinc die-cast

Crochet pour chapeau et manteau
▶ Zamak

- 1 Aluminium-Optik
Aluminium look
Aspect aluminium
- 2 Vermessingt, brüniert, glänzend
Brass-plated, burnished, gloss
Laitonné, bruni, brillant
- 3 Vermessingt, brüniert
Brass-plated, burnished
Laitonné, bruni
- 4 Silberfarben, brüniert
Silver coloured, burnished
Teinté argent, bruni



Nr./No./Ref.	EAN	↔ mm	↕ mm	↗ mm	VE/PU/Qte
1 9 207 951	40080571907736	68	155	80	1
2 9 207 953	40080571907750	68	155	80	1
3 9 207 950	40080571907729	68	155	80	1
4 9 207 952	40080571907743	68	155	80	1



Mantelhaken
▶ Zinkdruckguss

Coat hook
▶ Zinc die-cast

Crochet pour manteau
▶ Zamak

- 1 Vermessingt, brüniert
Brass-plated, burnished
Laitonné, bruni
- 2 Silberfarben, brüniert
Silver coloured, burnished
Teinté argent, bruni
- 3 Vermessingt, poliert
Brass-plated, polished
Laitonné, poli



Nr./No./Ref.	EAN	↔ mm	↕ mm	↗ mm	VE/PU/Qte
1 0 004 871	40080571048712	60	67	22	1
2 0 004 881	40080571048811	60	67	22	1
3 0 004 857	40080571048576	60	67	22	1



Hut- und Mantelhaken
▶ Zinkdruckguss

Hat and coat hook
▶ Zinc die-cast

Crochet pour chapeau et manteau
▶ Zamak

1 Silberfarben, brüniert
Silver coloured, burnished
Teinté argent, bruni

2 Vermessingt, brüniert
Brass-plated, burnished
Laitonné, bruni

3 Vermessingt, poliert
Brass-plated, polished
Laitonné, poli



Nr./No./Ref.	EAN	↔ mm	↕ mm	↗ mm	VE/PU/Qte
1 0 004 880	40080571048804	59	145	70	1
2 0 004 870	40080571048705	59	145	70	1
3 0 004 856	40080571048569	59	145	70	1



Mantelhaken
▶ Zinkdruckguss

Coat hook
▶ Zinc die-cast

Crochet pour manteau
▶ Zamak

1 Vermessingt, poliert
Brass-plated, polished
Laitonné, poli

2 Silberfarben, brüniert
Silver coloured, burnished
Teinté argent, bruni

3 Vermessingt, brüniert
Brass-plated, burnished
Laitonné, bruni



Nr./No./Ref.	EAN	↔ mm	↕ mm	↗ mm	VE/PU/Qte
1 0 004 853	40080571048538	58	69	26	1
2 0 004 967	40080571049672	58	69	26	1
3 0 004 926	40080571049269	58	69	26	1



Hut- und Mantelhaken
▶ Zinkdruckguss

Hat and coat hook
▶ Zinc die-cast

Crochet pour chapeau et manteau
▶ Zamak

1 Vermessingt, brüniert
Brass-plated, burnished
Laitonné, bruni

2 Silberfarben, brüniert
Silver coloured, burnished
Teinté argent, bruni

3 Vermessingt, poliert
Brass-plated, polished
Laitonné, poli



Nr./No./Ref.	EAN	↔ mm	↕ mm	↗ mm	VE/PU/Qte
1 0 004 925	40080571049252	58	145	70	1
2 0 004 966	40080571049665	58	145	70	1
3 0 004 852	40080571048521	58	145	70	1



1 Vernickelt
Nickel-plated
Nickelé

Hut- und Mantelhaken
▶ Zinkdruckguss

Hat and coat hook
▶ Zinc die-cast

Crochet pour chapeau et manteau
▶ Zamak

Nr./No./Ref.	EAN	↔ mm	↕ mm	↗ mm	VE/PU/Qte
1 9 207 945	400805719076751	38	90	75	1
2 9 207 944	400805719076681	38	90	75	1

2 Vermessingt, brüniert
Brass-plated, burnished
Laitonné, bruni



Vermessingt, brüniert
Brass-plated, burnished
Laitonné, bruni

Hut- und Mantelhaken
▶ Zinkdruckguss

Hat and coat hook
▶ Zinc die-cast

Crochet pour chapeau et manteau
▶ Zamak

Nr./No./Ref.	EAN	↔ mm	↕ mm	↗ mm	VE/PU/Qte
9 207 954	400805719077671	35	144	90	1



Vermessingt, brüniert
Brass-plated, burnished
Laitonné, bruni

Hut- und Mantelhaken
▶ Zinkdruckguss

Hat and coat hook
▶ Zinc die-cast

Crochet pour chapeau et manteau
▶ Zamak

Nr./No./Ref.	EAN	↔ mm	↕ mm	↗ mm	VE/PU/Qte
9 207 948	400805719077051	53	148	70	1



Vermessingt, brüniert
Brass-plated, burnished
Laitonné, bruni

Hut- und Mantelhaken
▶ Zinkdruckguss

Hat and coat hook
▶ Zinc die-cast

Crochet pour chapeau et manteau
▶ Zamak

Nr./No./Ref.	EAN	↔ mm	↕ mm	↗ mm	VE/PU/Qte
9 207 939	400805719076131	35	130	63	1



Vermessingt, brüniert
Brass-plated, burnished
Laitonné, bruni

Hut- und Mantelhaken
▶ Zinkdruckguss

Hat and coat hook
▶ Zinc die-cast

Crochet pour chapeau et manteau
▶ Zamak

Nr./No./Ref.	EAN	↔ mm	↕ mm	↗ mm	VE/PU/Qte
9 207 909	400805719074221	71	170	72	1



Hut- und Mantelhaken
▶ Zinkdruckguss

Hat and coat hook
▶ Zinc die-cast

Crochet pour chapeau et manteau
▶ Zamak

Silberfarben, brüniert
Silver coloured, burnished
Teinté argent, bruni

Nr./No./Ref.	EAN	↔ mm	↕ mm	↗ mm	VE/PU/Qte
9 207 908	40080571907415	48	175	60	1



Hut- und Mantelhaken
▶ Zinkdruckguss

Hat and coat hook
▶ Zinc die-cast

Crochet pour chapeau et manteau
▶ Zamak

Vermessingt, brüniert
Brass-plated, burnished
Laitonné, bruni

Nr./No./Ref.	EAN	↔ mm	↕ mm	↗ mm	VE/PU/Qte
0 004 872	40080571048729	76	175	73	1



Zierhaken
▶ Zinkdruckguss

Decorative hook
▶ Zinc die-cast

Crochet décoratif
▶ Zamak

1 Vermessingt
Brass-plated
Laitonné

Nr./No./Ref.	EAN	↔ mm	↕ mm	↗ mm	VE/PU/Qte
1 0 015 803	40080571158039	20	42	20	2
2 0 015 810	40080571158107	20	42	20	2

2 Vermessingt, brüniert
Brass-plated, burnished
Laitonné, bruni



Zierhaken
▶ Zinkdruckguss

Decorative hook
▶ Zinc die-cast

Crochet décoratif
▶ Zamak

1 Vermessingt, brüniert
Brass-plated, burnished
Laitonné, bruni

Nr./No./Ref.	EAN	↔ mm	↕ mm	↗ mm	VE/PU/Qte
1 0 015 809	40080571158091	21	52	26	2
2 0 015 802	40080571158022	21	52	26	2

2 Vermessingt
Brass-plated
Laitonné



Zierhaken
▶ Zinkdruckguss

Decorative hook
▶ Zinc die-cast

Crochet décoratif
▶ Zamak

Vermessingt
Brass-plated
Laitonné

Nr./No./Ref.	EAN	↔ mm	↕ mm	↗ mm	VE/PU/Qte
0 015 805	40080571158053	32	32	36	1



Country



Wohlfühlen inmitten der Natur. Für natürliche Behaglichkeit sorgt die Kollektion COUNTRY. Ihre traditionellen Formen, in Kombination mit Naturmaterialien, lassen ein gemütliches und warmes Ambiente im Wohnraum entstehen.

Feeling at ease amid nature. The COUNTRY collection conjures a sense of natural home comfort and warmth. Combined with natural materials, its traditional shapes create a cosy and warm ambience in the home.

Pour se sentir bien en pleine nature. La collection COUNTRY garantit un confort naturel. Ses formes traditionnelles combinées avec des matériaux naturels permettent de créer un habitat à ambiance chaleureuse et accueillante.



Motivgarderobe „Holzplanken“

- ▶ 5 Haken, vernickelt
- ▶ Holz / Zinkdruckguss
- ▶ Erweiterbar zur Türhängegarderobe mit Art. 9220838, Seite 71

„Wooden planks“ motif clothes rail

- ▶ 5 hooks, nickel-plated
- ▶ Wood laquered / zinc die-cast
- ▶ Can be turned into a door hanger clothes rail with art. no. 9220838, page 71

Garde-robe motif « Planches en bois »

- ▶ 5 crochets, nickelé
- ▶ Bois laqué / zamak
- ▶ Extension possible pour former une garde-robe à accrocher à la porte avec la réf. 9220838, page 71

Lackiert / vernickelt
Laquered / nickel-plated
Laqué / nickelé



Nr./No./Ref.	EAN	↔ mm	↕ mm	↗ mm	VE/PU/Qte
9 220 839	4 008 057 038 621	750	100	25	1



Garderobenleiste

- ▶ 3 Haken, verchromt
- ▶ Holz / Zinkdruckguss
- ▶ Erweiterbar zur Türhängegarderobe mit Art. 9220838, Seite 71

Clothes rail

- ▶ 3 hooks, chrome-plated
- ▶ Wood / zinc die-cast
- ▶ Can be turned into a door hanger clothes rail with art. no. 9220838, page 71

Patère

- ▶ 3 crochets, chromé
- ▶ Bois / zamak
- ▶ Extension possible pour former une garde-robe à accrocher à la porte avec la réf. 9220838, page 71

Weiß lackiert / verchromt
White laquered / chrome-plated
Laqué blanc / chromé



Nr./No./Ref.	EAN	↔ mm	↕ mm	↗ mm	VE/PU/Qte
9 216 145	4 008 057 039 666	300	80	75	1



Garderobenleiste

- ▶ 5 Haken, verchromt
- ▶ Holz / Zinkdruckguss
- ▶ Erweiterbar zur Türhängegarderobe mit Art. 9220838, Seite 71

Clothes rail

- ▶ 5 hooks, chrome-plated
- ▶ Wood / zinc die-cast
- ▶ Can be turned into a door hanger clothes rail with art. no. 9220838, page 71

Patère

- ▶ 5 crochets, chromé
- ▶ Bois / zamak
- ▶ Extension possible pour former une garde-robe à accrocher à la porte avec la réf. 9220838, page 71

Weiß lackiert / verchromt
White laquered / chrome-plated
Laqué blanc / chromé



Nr./No./Ref.	EAN	↔ mm	↕ mm	↗ mm	VE/PU/Qte
9 216 146	4 008 057 039 659	500	80	75	1



Garderobenleiste

- ▶ 3 Haken, verchromt
- ▶ Holz / Zinkdruckguss
- ▶ Erweiterbar zur Türhängegarderobe mit Art. 9220838, Seite 71

Clothes rail

- ▶ 3 hooks, chrome-plated
- ▶ Wood / zinc die-cast
- ▶ Can be turned into a door hanger clothes rail with art. no. 9220838, page 71

Patère

- ▶ 3 crochets, chromé
- ▶ Bois / zamak
- ▶ Extension possible pour former une garde-robe à accrocher à la porte avec la réf. 9220838, page 71

Schwarz lackiert / verchromt
Black laquered / chrome-plated
Laqué noir / chromé



Nr./No./Ref.	EAN	↔ mm	↕ mm	↗ mm	VE/PU/Qte
9 216 167	4 008 057 039 628	300	80	75	1



Garderobenleiste

- ▶ 5 Haken, verchromt
- ▶ Holz / Zinkdruckguss
- ▶ Erweiterbar zur Türhängegarderobe mit Art. 9220838, Seite 71

Clothes rail

- ▶ 5 hooks, chrome-plated
- ▶ Wood / zinc die-cast
- ▶ Can be turned into a door hanger clothes rail with art. no. 9220838, page 71

Patère

- ▶ 5 crochets, chromé
- ▶ Bois / zamak
- ▶ Extension possible pour former une garde-robe à accrocher à la porte avec la réf. 9220838, page 71

Schwarz lackiert / verchromt
Black laquered / chrome-plated
Laqué noir / chromé



Nr./No./Ref.	EAN	↔ mm	↕ mm	↗ mm	VE/PU/Qte
9 216 168	4 008 057 039 611	500	80	75	1



Garderobenleiste

- ▶ 3 Haken, schwarz
- ▶ Holz / Zinkdruckguss
- ▶ Erweiterbar zur Türhängegarderobe mit Art. 9220838, Seite 71

Clothes rail

- ▶ 3 hooks, black
- ▶ Wood / zinc die-cast
- ▶ Can be turned into a door hanger clothes rail with art. no. 9220838, page 71

Patère

- ▶ 3 crochets, noir
- ▶ Bois / zamak
- ▶ Extension possible pour former une garde-robe à accrocher à la porte avec la réf. 9220838, page 71

Weiß lackiert / schwarz
White laquered / black
Laqué blanc / noir



Nr./No./Ref.	EAN	↔ mm	↕ mm	↗ mm	VE/PU/Qte
9 216 169	4 008 057 039 642	400	80	96	1



Garderobenleiste

- ▶ 4 Haken, schwarz
- ▶ Holz / Zinkdruckguss
- ▶ Erweiterbar zur Türhängegarderobe mit Art. 9220838, Seite 71

Clothes rail

- ▶ 4 hooks, black
- ▶ Wood / zinc die-cast
- ▶ Can be turned into a door hanger clothes rail with art. no. 9220838, page 71

Patère

- ▶ 4 crochets, noir
- ▶ Bois / zamak
- ▶ Extension possible pour former une garde-robe à accrocher à la porte avec la réf. 9220838, page 71

Weiß lackiert / schwarz
White laquered / black
Laqué blanc / noir



Nr./No./Ref.	EAN	↔ mm	↕ mm	↗ mm	VE/PU/Qte
9 216 171	4 008 057 039 635	500	80	96	1



Hakenleiste

- ▶ 4 Haken
- ▶ Holz

Hook rack

- ▶ 4 hooks
- ▶ Wood

Barre à crochets

- ▶ 4 crochets
- ▶ Bois

Fichte, roh
Spruce, untreated
Épicéa, naturel

Nr./No./Ref.	EAN	↔ mm	↕ mm	↗ mm	VE/PU/Qte
0 006 000	4 008 057 060 004	240	35	55	1



Hakenleiste

- ▶ 5 Haken
- ▶ Holz

Hook rack

- ▶ 5 hooks
- ▶ Wood

Barre à crochets

- ▶ 5 crochets
- ▶ Bois

Fichte, roh
Spruce, untreated
Épicéa, naturel

Nr./No./Ref.	EAN	↔ mm	↕ mm	↗ mm	VE/PU/Qte
0 006 001	4 008 057 060 011	300	35	55	1



Hakenleiste

- ▶ 4 Haken
- ▶ Holz

Hook rack

- ▶ 4 hooks
- ▶ Wood

Barre à crochets

- ▶ 4 crochets
- ▶ Bois

Fichte, roh
Spruce, untreated
Épicéa, naturel

Nr./No./Ref.	EAN	↔ mm	↕ mm	↗ mm	VE/PU/Qte
0 006 003	4 008 057 060 035	300	50	60	1



Hakenleiste
 ▶ 5 Haken
 ▶ Holz

Hook rack
 ▶ 5 hooks
 ▶ Wood

Barre à crochets
 ▶ 5 crochets
 ▶ Bois

1 Fichte, lackiert
 Spruce, laquered
 Épicéa, laqué

Nr./No./Ref.	EAN	↔ mm	↕ mm	↗ mm	VE/PU/Qte
1 0 006 032	4008057060323	400	50	60	1
2 0 006 004	4008057060042	400	50	60	1

2 Fichte, roh
 Spruce, untreated
 Épicéa, naturel



Hakenleiste
 ▶ 4 Haken
 ▶ Holz

Hook rack
 ▶ 4 hooks
 ▶ Wood

Barre à crochets
 ▶ 4 crochets
 ▶ Bois

Buche, lackiert
 Beech, laquered
 Hêtre, laqué

Nr./No./Ref.	EAN	↔ mm	↕ mm	↗ mm	VE/PU/Qte
9 211 936	4008057035507	300	47	40	1



Garderobenleiste
 ▶ 5 Haken
 ▶ Stahl / Holz

Clothes rail
 ▶ 5 hooks
 ▶ Steel / wood

Patère
 ▶ 5 crochets
 ▶ Acier / bois

1 Schwarz / Buche, lackiert
 Black / beech, laquered
 Noir / hêtre, laqué

Nr./No./Ref.	EAN	↔ mm	↕ mm	↗ mm	VE/PU/Qte
1 0 016 194	4008057161947	430	135	65	1
2 0 016 196	4008057161961	430	135	65	1

2 Vernickelt / Buche, lackiert
 Nickel-plated / beech, laquered
 Nickelé / hêtre, laqué



Türhängegarderobe
 ▶ 4 Haken
 ▶ Stahl / Holz

Door hanger clothes rail
 ▶ 4 hooks
 ▶ Steel / wood

Garde-robe à accrocher à la porte
 ▶ 4 crochets
 ▶ Acier / bois

Verchromt / Buche, lackiert
 Chrome-plated / beech, laquered
 Chromé / hêtre, laqué

Nr./No./Ref.	EAN	mm	↔ mm	↕ mm	↗ mm	VE/PU/Qte
0 047 154	4008057471541	30	370	370	100	1



Türhängegarderobe
 ▶ 5 Haken
 ▶ Stahl / Holz

Door hanger clothes rail
 ▶ 5 hooks
 ▶ Steel / wood

Garde-robe à accrocher à la porte
 ▶ 5 crochets
 ▶ Acier / bois

Aluminium-Optik / Buche, lackiert
 Aluminium look / beech, laquered
 Aspect aluminium / hêtre, laqué

Nr./No./Ref.	EAN	mm	↔ mm	↕ mm	↗ mm	VE/PU/Qte
0 060 517	4008057605175	20	465	155	85	1



Mantelhaken
▶ Holz

Coat hook
▶ Wood

Crochet pour manteau
▶ Bois

Kiefer, roh
Pine, untreated
Pin, naturel

Nr./No./Ref.	EAN	↔ mm	↕ mm	↗ mm	VE/PU/Qte
0 004 272	4008057042727	22	22	65	1 



Mantelhaken
▶ Holz

Coat hook
▶ Wood

Crochet pour manteau
▶ Bois

Kiefer, roh
Pine, untreated
Pin, naturel

Nr./No./Ref.	EAN	↔ mm	↕ mm	↗ mm	VE/PU/Qte
0 004 274	4008057042741	50	50	100	1 



Haken
▶ Selbstklebend
▶ Porzellan

Hook
▶ Self-adhesive
▶ Porcelain

Crochet
▶ Auto adhésif
▶ Porcelaine

Weiß
White
Blanc

Nr./No./Ref.	EAN	↔ mm	↕ mm	↗ mm	VE/PU/Qte
0 015 682	4008057156820	37	37	21	1 



Classic

Klassische Formen, Farben und Materialien finden sich in der Kollektion CLASSIC wieder. Ob einfach oder extravagant, mit dem zeitlosen Design passt sich diese Kollektion jedem Wohnraum an.

Classic shapes, colours and materials are reflected in the CLASSIC collection. Whether simple or extravagant, the timeless design of this collection goes with any living space.

La collection CLASSIC est empreinte de formes, de coloris et de matériaux classiques. Que ce soit simple ou extravagante, cette collection s'adapte à merveille à tous les habitats avec son design intemporel.



Hut- und Mantelhaken

- ▶ Doppelhaken
- ▶ Stahl

Hat and coat hook

- ▶ Double hook
- ▶ Steel

Crochet pour chapeau et manteau

- ▶ Crochet double
- ▶ Acier

1 Silberfarben
Silver coloured
Teinté argent

Nr./No./Ref.	EAN	↔ mm	↕ mm	↗ mm	VE/PU/Qte
1 0 005 650	4008057056502	52	165	65	1
2 0 005 710	4008057057103	52	165	65	1

2 Weiß
White
Blanc



Garderobenleiste

- ▶ 2 Doppelhaken
- ▶ Stahl

Clothes rail

- ▶ 2 double hooks
- ▶ Steel

Patère

- ▶ 2 crochets doubles
- ▶ Acier

1 Weiß
White
Blanc

Nr./No./Ref.	EAN	↔ mm	↕ mm	↗ mm	VE/PU/Qte
1 0 005 711	4008057057110	285	165	75	1
2 0 005 651	4008057056519	285	165	75	1

2 Silberfarben
Silver coloured
Teinté argent



Garderobenleiste

- ▶ 3 Doppelhaken
- ▶ Stahl

Clothes rail

- ▶ 3 double hooks
- ▶ Steel

Patère

- ▶ 3 crochets doubles
- ▶ Acier

1 Silberfarben
Silver coloured
Teinté argent

Nr./No./Ref.	EAN	↔ mm	↕ mm	↗ mm	VE/PU/Qte
1 0 005 652	4008057056526	430	165	75	1
2 0 005 712	4008057057127	430	165	75	1

2 Weiß
White
Blanc



Garderobenleiste

- ▶ 4 Doppelhaken
- ▶ Stahl

Clothes rail

- ▶ 4 double hooks
- ▶ Steel

Patère

- ▶ 4 crochets doubles
- ▶ Acier

Weiß
White
Blanc

Nr./No./Ref.	EAN	↔ mm	↕ mm	↗ mm	VE/PU/Qte
0 005 713	4008057057134	575	165	75	1



Drehhaken für Unterbaumontage

- ▶ 3 Haken
- ▶ Zinkdruckguss

Screw in hook for base frame mounting

- ▶ 3 hooks
- ▶ Zinc die-cast

Crochet tournant pour le plafond

- ▶ 3 crochets
- ▶ Zamak

Silberfarben
Silver coloured
Teinté argent

Nr./No./Ref.	EAN	↔ mm	↕ mm	↗ mm	VE/PU/Qte
0 005 894	4008057058940	63	67	63	1



Mantelhaken
▶ Zinkdruckguss

Coat hook
▶ Zinc die-cast

Crochet pour manteau
▶ Zamak

1 Aluminium-Optik
Aluminium look
Aspect aluminium

2 Verchromt
Chrome-plated
Chromé

3 Vernickelt
Nickel-plated
Nickelé

4 Vermessingt
Brass-plated
Laitonné

5 Vermessingt, brüniert
Brass-plated, burnished
Laitonné, bruni



Nr./No./Ref.	EAN	↔ mm	↕ mm	↗ mm	VE/PU/Qte
1 9 207 962	4008057907798	77	47	30	1
2 9 207 967	4008057907835	77	47	30	1
3 9 207 960	4008057907781	77	47	30	1
4 9 207 972	4008057907880	77	47	30	1
5 9 207 956	4008057907774	77	47	30	1



Hut- und Mantelhaken
▶ Zinkdruckguss

Hat and coat hook
▶ Zinc die-cast

Crochet pour chapeau et manteau
▶ Zamak

1 Vermessingt, brüniert
Brass-plated, burnished
Laitonné, bruni

2 Aluminium-Optik
Aluminium look
Aspect aluminium

3 Verchromt
Chrome-plated
Chromé

4 Vernickelt
Nickel-plated
Nickelé

5 Vermessingt
Brass-plated
Laitonné



Nr./No./Ref.	EAN	↔ mm	↕ mm	↗ mm	VE/PU/Qte
1 9 207 925	4008057907576	77	125	75	1
2 9 207 924	4008057907569	77	125	75	1
3 9 207 938	4008057907606	77	125	75	1
4 9 207 923	4008057907552	77	125	75	1
5 9 207 943	4008057907651	77	125	75	1



Mantelhaken
▶ Zinkdruckguss

Coat hook
▶ Zinc die-cast

Crochet pour manteau
▶ Zamak

1 Verchromt
Chrome-plated
Chromé

Nr./No./Ref.	EAN	↔ mm	↕ mm	↗ mm	VE/PU/Qte
1 9 207 918	40080571907507	78	58	31	1
2 9 207 914	40080571907460	78	58	31	1
3 9 207 915	40080571907477	78	58	31	1

2 Aluminium-Optik
Aluminium look
Aspect aluminium



3 Vernickelt
Nickel-plated
Nickelé



Hut- und Mantelhaken
▶ Zinkdruckguss

Hat and coat hook
▶ Zinc die-cast

Crochet pour chapeau et manteau
▶ Zamak

1 Aluminium-Optik
Aluminium look
Aspect aluminium

Nr./No./Ref.	EAN	↔ mm	↕ mm	↗ mm	VE/PU/Qte
1 9 207 905	40080571907385	78	150	60	1
2 9 207 907	40080571907408	78	150	60	1
3 9 207 906	40080571907392	78	150	60	1

2 Verchromt
Chrome-plated
Chromé



3 Vernickelt
Nickel-plated
Nickelé



Mantelhaken
▶ Zinkdruckguss

Coat hook
▶ Zinc die-cast

Crochet pour manteau
▶ Zamak

Vernickelt
Nickel-plated
Nickelé

Nr./No./Ref.	EAN	↔ mm	↕ mm	↗ mm	VE/PU/Qte
0 004 984	40080571049849	75	50	32	1



Hut- und Mantelhaken
▶ Zinkdruckguss

Hat and coat hook
▶ Zinc die-cast

Crochet pour chapeau et manteau
▶ Zamak

Vernickelt
Nickel-plated
Nickelé

Nr./No./Ref.	EAN	↔ mm	↕ mm	↗ mm	VE/PU/Qte
0 004 983	40080571049832	76	96	90	1

Mantelhaken

▶ Zinkdruckguss

Coat hook

▶ Zinc die-cast

Crochet pour manteau

▶ Zamak



1 Weiß
White
Blanc



2 Braun
Brown
Brun

Nr./No./Ref.	EAN	↔ mm	↕ mm	↗ mm	VE/PU/Qte
1 0 004 412	4008057044127	72	43	49	1
2 0 018 094	4008057180948	72	43	49	1

Hut- und Mantelhaken

▶ Zinkdruckguss

Hat and coat hook

▶ Zinc die-cast

Crochet pour chapeau et manteau

▶ Zamak



1 Braun
Brown
Brun



2 Weiß
White
Blanc

Nr./No./Ref.	EAN	↔ mm	↕ mm	↗ mm	VE/PU/Qte
1 0 004 409	4008057044097	66	108	98	1
2 0 004 411	4008057044110	66	108	98	1

Mantelhaken

▶ Zinkdruckguss

Coat hook

▶ Zinc die-cast

Crochet pour manteau

▶ Zamak



1 Schwarz verchromt
Black chrome-plated
Chromé noir



2 Aluminium-Optik
Aluminium look
Aspect aluminium



3 Verchromt
Chrome-plated
Chromé



4 Vernickelt
Nickel-plated
Nickelé



5 Vermessingt, brüniert
Brass-plated, burnished
Laitonné, bruni

Nr./No./Ref.	EAN	↔ mm	↕ mm	↗ mm	VE/PU/Qte
1 9 207 971	4008057907873	55	60	22	1
2 0 014 137	4008057141376	55	60	22	1
3 9 207 970	4008057907866	55	60	22	1
4 9 207 969	4008057907859	55	60	22	1
5 9 207 968	4008057907842	55	60	22	1

Mantelhaken ▶ Zinkdruckguss



1 Aluminium-Optik
Aluminium look
Aspect aluminium

2 Verchromt
Chrome-plated
Chromé

3 Vernickelt
Nickel-plated
Nickelé

4 Vermessingt, brüniert
Brass-plated, burnished
Laitonné, bruni



Coat hook ▶ Zinc die-cast

Crochet pour manteau ▶ Zamak

Nr./No./Ref.	EAN	↔ mm	↕ mm	↗ mm	VE/PU/Qte
1 9 207 966	40080571907828	54	44	24	1
2 9 207 965	40080571907811	54	44	24	1
3 9 207 964	40080571907804	54	44	24	1
4 9 207 977	40080571907934	54	44	24	1

Zierhaken ▶ Zinkdruckguss



1 Weiß
White
Blanc

2 Braun
Brown
Brun

3 Aluminium-Optik
Aluminium look
Aspect aluminium



Decorative hook ▶ Zinc die-cast

Crochet décoratif ▶ Zamak

Nr./No./Ref.	EAN	↔ mm	↕ mm	↗ mm	VE/PU/Qte
1 0 015 821	40080571158213	42	35	23	2
2 0 015 820	40080571158206	42	35	23	2
3 0 018 152	40080571181525	42	35	23	1

Mantelhaken ▶ Zinkdruckguss



1 Vermessingt, brüniert
Brass-plated, burnished
Laitonné, bruni

2 Aluminium-Optik
Aluminium look
Aspect aluminium

3 Verchromt
Chrome-plated
Chromé

4 Vernickelt
Nickel-plated
Nickelé

5 Vermessingt
Brass-plated
Laitonné



Coat hook ▶ Zinc die-cast

Crochet pour manteau ▶ Zamak

Nr./No./Ref.	EAN	↔ mm	↕ mm	↗ mm	VE/PU/Qte
1 9 207 919	40080571907514	58	31	29	1
2 9 207 920	40080571907521	58	31	29	1
3 9 207 916	40080571907484	58	31	29	1
4 9 207 917	40080571907491	58	31	29	1
5 9 207 922	40080571907545	58	31	29	1



Mantelhaken
▶ Zinkdruckguss

Coat hook
▶ Zinc die-cast

Crochet pour manteau
▶ Zamak

Edelstahl-Optik
Stainless steel look
Aspect acier affiné

Nr./No./Ref.	EAN	↔ mm	↕ mm	↗ mm	VE/PU/Qte
9 207 941	40080571907637	51	91	56	1



Mantelhaken
▶ Zinkdruckguss

Coat hook
▶ Zinc die-cast

Crochet pour manteau
▶ Zamak

Aluminium-Optik
Aluminium look
Aspect aluminium

Nr./No./Ref.	EAN	↔ mm	↕ mm	↗ mm	VE/PU/Qte
0 005 645	40080571056458	49	77	61	1



Mantelhaken
▶ Zinkdruckguss

Coat hook
▶ Zinc die-cast

Crochet pour manteau
▶ Zamak

1 Weiß
White
Blanc

Nr./No./Ref.	EAN	↔ mm	↕ mm	↗ mm	VE/PU/Qte
1 0 040 012	40080571400121	33	40	55	1
2 0 040 011	40080571400114	33	40	55	1

2 Aluminium-Optik
Aluminium look
Aspect aluminium



Mantelhaken
▶ Zinkdruckguss

Coat hook
▶ Zinc die-cast

Crochet pour manteau
▶ Zamak

1 Edelstahl-Optik
Stainless steel look
Aspect acier affiné

Nr./No./Ref.	EAN	↔ mm	↕ mm	↗ mm	VE/PU/Qte
1 0 005 996	40080571059961	18	18	30	1
2 0 005 995	40080571059954	18	18	30	1

2 Verchromt
Chrome-plated
Chromé





Zierhaken

- ▶ Inkl. Stockschraube
- ▶ Zinkdruckguss

Decorative hook

- ▶ Including hanger bolt
- ▶ Zinc die-cast

Crochet décoratif

- ▶ Y compris vis à double filetage
- ▶ Zamak

- 1 Aluminium-Optik
Aluminium look
Aspect aluminium

- 2 Verchromt
2 Chrome-plated
Chromé

- 3 Vernickelt
Nickel-plated
Nickelé

- 4 Vermessingt, brüniert
Brass-plated, burnished
Laitonné, bruni



Nr./No./Ref.	EAN	↔ mm	↕ mm	↗ mm	VE/PU/Qte
1 9 215 095	4008057037068	20	36	43	1
2 9 207 927	4008057907590	20	36	43	1
3 9 207 926	4008057907583	20	36	43	1
4 9 215 096	4008057037075	20	36	43	1



Zierhaken

- ▶ Inkl. Stockschraube
- ▶ Zinkdruckguss

Decorative hook

- ▶ Including hanger bolt
- ▶ Zinc die-cast

Crochet décoratif

- ▶ Y compris vis à double filetage
- ▶ Zamak

- 1 Edelstahl-Optik
Stainless steel look
Aspect acier affiné

- 2 Aluminium-Optik
Aluminium look
Aspect aluminium

- 3 Verchromt
Chrome-plated
Chromé

- 4 Vernickelt
Nickel-plated
Nickelé

- 5 Vermessingt, brüniert
Brass-plated, burnished
Laitonné, bruni

- 6 Weiß
White
Blanc



Nr./No./Ref.	EAN	↔ mm	↕ mm	↗ mm	VE/PU/Qte
1 9 215 086	4008057036863	12	28	35	1
2 9 215 087	4008057036870	12	28	35	1
3 9 215 083	4008057036832	12	28	35	1
4 9 215 085	4008057036856	12	28	35	1
5 9 215 084	4008057036849	12	28	35	1
6 9 215 088	4008057036887	12	28	35	1



Zierhaken

- ▶ Inkl. Stockschraube
- ▶ Zinkdruckguss

Decorative hook

- ▶ Including hanger bolt
- ▶ Zinc die-cast

Crochet décoratif

- ▶ Y compris vis à double filetage
- ▶ Zamak

1 Vermessingt, matt
Matt brass-plated
Mat laitonné

2 Vermessingt, brüniert
Brass-plated, burnished
Laitonné, bruni

3 Edelstahl-Optik
Stainless steel look
Aspect acier affiné

4 Aluminium-Optik
Aluminium look
Aspect aluminium

5 Verchromt
Chrome-plated
Chromé

6 Vernickelt
Nickel-plated
Nickelé



Nr./No./Ref.	EAN	↔ mm	↕ mm	↗ mm	VE/PU/Qte
1 9 215 094	4008057037051	15	32	44	1
2 9 215 090	4008057036962	15	32	44	1
3 9 215 092	4008057037006	15	32	44	1
4 9 215 093	4008057037013	15	32	44	1
5 9 215 089	4008057036894	15	32	44	1
6 9 215 091	4008057036993	15	32	44	1



Zierhaken

- ▶ Zinkdruckguss

Decorative hook

- ▶ Zinc die-cast

Crochet décoratif

- ▶ Zamak

Vernickelt
Nickel-plated
Nickelé

Nr./No./Ref.	EAN	↔ mm	↕ mm	↗ mm	VE/PU/Qte
0 015 825	4008057158251	20	28	30	2



Zierhaken

- ▶ Zinkdruckguss

Decorative hook

- ▶ Zinc die-cast

Crochet décoratif

- ▶ Zamak

Verchromt
Chrome-plated
Chromé

Nr./No./Ref.	EAN	↔ mm	↕ mm	↗ mm	VE/PU/Qte
0 015 826	4008057158268	18	25	30	2



Mantelhaken

- ▶ Zinkdruckguss

Coat hook

- ▶ Zinc die-cast

Crochet pour manteau

- ▶ Zamak

Aluminium-Optik
Aluminium look
Aspect aluminium

Nr./No./Ref.	EAN	↔ mm	↕ mm	↗ mm	VE/PU/Qte
0 014 109	4008057141093	25	25	30	1



Hut- und Mantelhaken
▶ Zinkdruckguss

Hat and coat hook
▶ Zinc die-cast

Crochet pour chapeau et manteau
▶ Zamak

Aluminium-Optik
Aluminium look
Aspect aluminium

Nr./No./Ref.	EAN	↔ mm	↕ mm	↗ mm	VE/PU/Qte
0 014 123	40080571141239	13	46	38	1



Mantelhaken
▶ Zinkdruckguss

Coat hook
▶ Zinc die-cast

Crochet pour manteau
▶ Zamak

Aluminium-Optik
Aluminium look
Aspect aluminium

Nr./No./Ref.	EAN	↔ mm	↕ mm	↗ mm	VE/PU/Qte
0 014 125	40080571141253	20	20	54	1



Mantelhaken
▶ Zinkdruckguss

Coat hook
▶ Zinc die-cast

Crochet pour manteau
▶ Zamak

Aluminium-Optik
Aluminium look
Aspect aluminium

Nr./No./Ref.	EAN	↔ mm	↕ mm	↗ mm	VE/PU/Qte
0 005 990	40080571059909	18	18	57	1



Colours & Kids



Nicht nur im Kinderzimmer ist die Kollektion COLOURS & KIDS ein Blickfang. Das farbenfrohe und verspielte Design dieser Kollektion verleiht jedem Raum einen frischen Charakter, ganz nach den persönlichen Vorstellungen seines Besitzers.

The COLOURS & KIDS collection not only makes an eyecatcher in children's rooms. The colourful and playful design of this collection brings a fresh look to any piece of furniture, perfectly in keeping with the personal taste of its owner.

La collection COLOURS & KIDS n'attire pas seulement tous les regards dans la chambre des enfants. Le design ludique et coloré de cette collection donne à chaque meuble un caractère frais faisant ressortir la personnalité de son propriétaire.



Motivgarderobe „Punkte“

- ▶ 4 Haken, weiß
- ▶ Holz
- ▶ Erweiterbar zur Türhängegarderobe mit Art. 9220838, Seite 71

„Dots“ motif clothes rail

- ▶ 4 hooks, white
- ▶ Wood
- ▶ Can be turned into a door hanger clothes rail with art. no. 9220838, page 71

Garde-robe motif « Pois »

- ▶ 4 crochets, blanc
- ▶ Bois
- ▶ Extension possible pour former une garde-robe à accrocher à la porte avec la réf. 9220838, page 71

1 Weiß / blau, lackiert
White / blue, laquered
Blanc / bleu, laqué



2 Weiß / pink, lackiert
White / pink, laquered
Blanc / fuchsia, laqué



Nr./No./Ref.	EAN	↔ mm	↕ mm	↗ mm	VE/PU/Qte
1 9 220 843	4008057038669	500	100	45	1
2 9 220 844	4008057038676	500	100	45	1



Motivgarderobe „Neonstreifen“

- ▶ 5 Haken, grün, pink
- ▶ Holz
- ▶ Erweiterbar zur Türhängegarderobe mit Art. 9220838, Seite 71

„Neon strip light“ motif clothes rail

- ▶ 5 hooks, green, pink
- ▶ Wood
- ▶ Can be turned into a door hanger clothes rail with art. no. 9220838, page 71

Garde-robe motif « Bandes néon »

- ▶ 5 crochets, vert, fuchsia
- ▶ Bois
- ▶ Extension possible pour former une garde-robe à accrocher à la porte avec la réf. 9220838, page 71

Grün, pink / lackiert
Green, pink / laquered
Vert, fuchsia / laqué



Nr./No./Ref.	EAN	↔ mm	↕ mm	↗ mm	VE/PU/Qte
9 220 841	4008057038645	750	100	48	1



Garderobe mit Ablage

- ▶ 3 Haken, verchromt
- ▶ Ablage 95 mm
- ▶ Stahl

Clothes rail with shelf

- ▶ 3 hooks, chrome-plated
- ▶ Shelf 95 mm
- ▶ Steel

Garde-robe avec étagère

- ▶ 3 crochets, chromé
- ▶ Étagère 95 mm
- ▶ Acier

1 Mint / verchromt
Mint / chrome-plated
Mint / chromé

2 Pink / verchromt
Pink / chrome-plated
Fuchsia / chromé



3 Blau / verchromt
Blue / chrome-plated
Bleu / chromé



4 Weiß / verchromt
White / chrome-plated
Blanc / chromé



Nr./No./Ref.	EAN	↔ mm	↕ mm	↗ mm	VE/PU/Qte
1 9 220 836	4008057038591	300	100	100	1
2 9 220 835	4008057038584	300	100	100	1
3 9 220 837	4008057038607	300	100	100	1
4 9 220 832	4008057038577	300	100	100	1



Kindergarderobenleiste

- ▶ Tiger und Löwe
- ▶ 4 Haken
- ▶ Holz

Children's clothes rail

- ▶ Tiger and lion
- ▶ 4 hooks
- ▶ Wood

Patère enfants

- ▶ Tigre et lion
- ▶ 4 crochets
- ▶ Bois

Mehrfarbig
Multicolored
Multicolore

Nr./No./Ref.	EAN	↔ mm	↕ mm	↗ mm	VE/PU/Qte
9 137 427	4008057016261	305	170	35	1



Kindergarderobenleiste

- ▶ Marienkäfer
- ▶ 4 Haken
- ▶ Holz

Children's clothes rail

- ▶ Ladybird
- ▶ 4 hooks
- ▶ Wood

Patère enfants

- ▶ Coccinelle
- ▶ 4 crochets
- ▶ Bois

Nr./No./Ref.	EAN	↔ mm	↕ mm	↗ mm	VE/PU/Qte
9 137 485	4008057016476	325	135	35	1

Mehrfarbig
Multicolored
Multicolore



Kindergarderobenleiste

- ▶ Elefanten
- ▶ 4 Haken
- ▶ Holz

Children's clothes rail

- ▶ Elephants
- ▶ 4 hooks
- ▶ Wood

Patère enfants

- ▶ Éléphants
- ▶ 4 crochets
- ▶ Bois

Nr./No./Ref.	EAN	↔ mm	↕ mm	↗ mm	VE/PU/Qte
9 211 916	4008057035415	325	145	35	1

Mehrfarbig
Multicolored
Multicolore



Türhängegarderobe

- ▶ Fisch
- ▶ Stahl

Door hanger clothes rail

- ▶ Fish
- ▶ Steel

Garde-robe à accrocher à la porte

- ▶ Poisson
- ▶ Acier

Nr./No./Ref.	EAN	mm	↔ mm	↕ mm	↗ mm	VE/PU/Qte
9 084 194	4008057856669	16	80	103	57	1

Verchromt
Chrome-plated
Chromé



Türhängegarderobe

- ▶ Wal
- ▶ Stahl

Door hanger clothes rail

- ▶ Whale
- ▶ Steel

Garde-robe à accrocher à la porte

- ▶ Baleine
- ▶ Acier

Nr./No./Ref.	EAN	mm	↔ mm	↕ mm	↗ mm	VE/PU/Qte
9 084 195	4008057856676	16	86	100	57	1

Verchromt
Chrome-plated
Chromé



Türhängegarderobe

- ▶ Männchen
- ▶ Stahl / Keramik

Door hanger clothes rail

- ▶ Little man
- ▶ Steel / ceramic

Garde-robe à accrocher à la porte

- ▶ Bonhomme
- ▶ Acier / céramique

Nr./No./Ref.	EAN	mm	↔ mm	↕ mm	↗ mm	VE/PU/Qte
9 084 193	4008057856652	20	480	190	73	1

Verchromt / mehrfarbig
Chrome-plated / multicolored
Chromé / multicolore



BUDGET



Einfach und praktisch durch den Alltag. Universell einsetzbare Alleskönner hat die Kollektion BUDGET zu bieten. Diese zweckmäßig konzipierte Kollektion, mit ihren dezenten Formen und einfachen Materialien, bietet viele Möglichkeiten, das eigene Zuhause zu organisieren und den vorhandenen Raum optimal zu nutzen.

Getting through everyday life the easy and practical way. The BUDGET collection features universal all rounders. Understated shapes and simple materials make substantial pieces of furniture look like new again.

Simple et pratique dans la vie de tous les jours. La collection BUDGET propose des produits polyvalents utilisables de manière universelle. Des formes sobres et des matériaux simples donnent une seconde vie aux meubles solides.



Hut- und Mantelhaken
▶ Kunststoff

Hat and coat hook
▶ Plastic

Crochet pour chapeau et manteau
▶ Plastique

1 Anthrazit
Anthracite
Anthracite

2 Schwarz
Black
Noir

3 Weiß
White
Blanc



Nr./No./Ref.	EAN	↔ mm	↕ mm	↗ mm	VE/PU/Qte
1 0 005 984	4008057059848	56	150	70	1
2 0 005 682	4008057056823	56	150	70	1
3 0 005 681	4008057056816	56	150	70	1



Garderobenleiste
▶ 2 Haken
▶ Kunststoff

Clothes rail
▶ 2 hooks
▶ Plastic

Patère
▶ 2 Haken
▶ Plastique

1 Schwarz
Black
Noir

2 Anthrazit
Anthracite
Anthracite

3 Weiß
White
Blanc



Nr./No./Ref.	EAN	↔ mm	↕ mm	↗ mm	VE/PU/Qte
1 0 005 965	4008057059657	163	150	70	1
2 0 005 985	4008057059855	163	150	70	1
3 0 005 966	4008057059664	163	150	70	1



Garderobenleiste
▶ 4 Haken
▶ Kunststoff

Clothes rail
▶ 4 hooks
▶ Plastic

Patère
▶ 4 crochets
▶ Plastique

1 Weiß
White
Blanc

2 Schwarz
Black
Noir

3 Anthrazit
Anthracite
Anthracite



Nr./No./Ref.	EAN	↔ mm	↕ mm	↗ mm	VE/PU/Qte
1 0 005 962	4008057059626	370	150	70	1
2 0 005 963	4008057059633	370	150	70	1
3 0 005 986	4008057059862	370	150	70	1



Haushaltsleiste
 ▶ 4 Haken
 ▶ Metall

Hook rack
 ▶ 4 hooks
 ▶ Metal

Barre à crochets
 ▶ 4 crochets
 ▶ Métal

- 1 Weiß
White
Blanc
- 2 Goldfarben
Gold coloured
Teinte dorée



Nr./No./Ref.	EAN	↔ mm	↕ mm	↗ mm	VE/PU/Qte
1 0 004 406	4008057044066	270	20	30	1
2 0 004 418	4008057044189	270	20	30	1



Haushaltsleiste
 ▶ 5 Haken
 ▶ Metall

Hook rack
 ▶ 5 hooks
 ▶ Metal

Barre à crochets
 ▶ 5 crochets
 ▶ Métal

- 1 Braun
Brown
Brun
- 2 Weiß
White
Blanc
- 3 Goldfarben
Gold coloured
Teinte dorée



Nr./No./Ref.	EAN	↔ mm	↕ mm	↗ mm	VE/PU/Qte
1 0 004 422	4008057044226	340	20	30	1
2 0 004 407	4008057044073	340	20	30	1
3 0 004 419	4008057044196	340	20	30	1



Einzelhaken
 ▶ Stahl

Single hook
 ▶ Steel

Crochet simple
 ▶ Acier

Verchromt
Chrome-plated
Chromé

Nr./No./Ref.	EAN	↔ mm	↕ mm	↗ mm	VE/PU/Qte
0 012 697	4008057126977	8	48	35	1



Hakenleiste
 ▶ 3 Haken
 ▶ Stahl

Hook rack
 ▶ 3 hooks
 ▶ Steel

Barre à crochets
 ▶ 3 crochets
 ▶ Acier

Verchromt
Chrome-plated
Chromé



Nr./No./Ref.	EAN	↔ mm	↕ mm	↗ mm	VE/PU/Qte
0 012 923	4008057129237	200	52	35	1



Hakenleiste
 ▶ 5 Haken
 ▶ Stahl

Hook rack
 ▶ 5 hooks
 ▶ Steel

Barre à crochets
 ▶ 5 crochets
 ▶ Acier

Verchromt
Chrome-plated
Chromé



Nr./No./Ref.	EAN	↔ mm	↕ mm	↗ mm	VE/PU/Qte
0 012 693	4008057126939	350	52	35	1

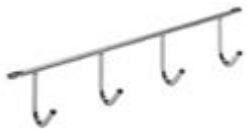

Hakenleiste für Unterbaumontage

- ▶ 4 Haken
- ▶ Stahl

Hook rack for base frame mounting

- ▶ 4 hooks
- ▶ Steel

Barre à crochets pour montage sous châssis

- ▶ 4 crochets
- ▶ Acier

Verchromt
Chrome-plated
Chromé



Nr./No./Ref.	EAN	↔ mm	↕ mm	↗ mm	VE/PU/Qte
0 012 699	4 008 057 126 991	275	52	35	1



Türhängegarderobe

- ▶ 4 Haken
- ▶ Stahl

Door hanger clothes rail

- ▶ 4 hooks
- ▶ Steel

Garde-robe à accrocher à la porte

- ▶ 4 crochets
- ▶ Acier

Verchromt
Chrome-plated
Chromé

Nr./No./Ref.	EAN	mm	↔ mm	↕ mm	↗ mm	VE/PU/Qte
9 199 026	4 008 057 030 533	20	290	165	95	1

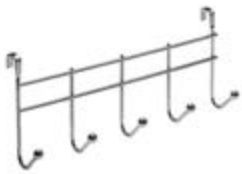

Türhängegarderobe

- ▶ 5 Haken
- ▶ Stahl

Door hanger clothes rail

- ▶ 5 hooks
- ▶ Steel

Garde-robe à accrocher à la porte

- ▶ 5 crochets
- ▶ Acier

Verchromt
Chrome-plated
Chromé

Nr./No./Ref.	EAN	mm	↔ mm	↕ mm	↗ mm	VE/PU/Qte
9 199 025	4 008 057 030 526	20	375	165	95	1

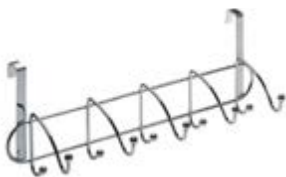

Türhängegarderobe

- ▶ 5 Doppelhaken
- ▶ Stahl

Door hanger clothes rail

- ▶ 5 double hooks
- ▶ Steel

Garde-robe à accrocher à la porte

- ▶ 5 crochets doubles
- ▶ Acier

Verchromt
Chrome-plated
Chromé

Nr./No./Ref.	EAN	mm	↔ mm	↕ mm	↗ mm	VE/PU/Qte
9 199 024	4 008 057 030 328	20	430	155	135	1



Türhängehaken

- ▶ Kunststoff

Door hanger hook

- ▶ Plastic

Crochet à accrocher à la porte

- ▶ Plastique

1 Weiß
White
Blanc

Nr./No./Ref.	EAN	mm	↔ mm	↕ mm	↗ mm	VE/PU/Qte
9 112 706	4 008 057 150 309	20	22	70	50	1
9 112 704	4 008 057 150 293	20	22	70	50	1

2 Braun
Brown
Brun





Mantelhaken
▶ Kunststoff

Coat hook
▶ Plastic

Crochet pour manteau
▶ Plastique

1 Schwarz
Black
Noir

2 Weiß
White
Blanc

3 Braun
Brown
Brun



Nr./No./Ref.	EAN	↔ mm	↕ mm	↗ mm	VE/PU/Qte
1 0 004 907	4008057049078	18	51	57	1
2 0 004 909	4008057049092	18	51	57	1
3 0 004 997	4008057049979	18	51	57	1



Hut- und Mantelhaken
▶ Kunststoff

Hat and coat hook
▶ Plastic

Crochet pour chapeau et manteau
▶ Plastique

1 Braun
Brown
Brun

2 Schwarz
Black
Noir

3 Weiß
White
Blanc



Nr./No./Ref.	EAN	↔ mm	↕ mm	↗ mm	VE/PU/Qte
1 0 004 912	4008057049122	18	135	90	1
2 0 004 908	4008057049085	18	135	90	1
3 0 004 900	4008057049009	18	135	90	1



Haken
▶ Stahl

Haken
▶ Steel

Haken
▶ Acier

1 Vernickelt
Nickel-plated
Nickelé

2 Weiß
White
Blanc



Nr./No./Ref.	EAN	↔ mm	↕ mm	↗ mm	VE/PU/Qte
1 9 207 911	4008057907446	23	33	25	1
2 9 207 913	4008057907453	23	33	25	1



Zierhaken
▶ Zinkdruckguss

Decorative hook
▶ Zinc die-cast

Crochet décoratif
▶ Zamak

Aluminium-Optik
Aluminium look
Aspect aluminium

Nr./No./Ref.	EAN	↔ mm	↕ mm	↗ mm	VE/PU/Qte
0 015 814	4008057158145	49	49	27	1



Saughaken
▶ Kunststoff

Suction hook
▶ Plastic

Crochet à ventouse
▶ Plastique

Transparent
Transparent
Transparent

Nr./No./Ref.	EAN	↔ mm	↕ mm	↗ mm	VE/PU/Qte
0 002 309	4008057023092	45	45	25	3
0 018 148	4008057181488	45	45	25	4



Zierhaken
▶ Kunststoff

Decorative hook
▶ Plastic

Crochet décoratif
▶ Plastique

Weiß
White
Blanc

Nr./No./Ref.	EAN	↔ mm	↕ mm	↗ mm	VE/PU/Qte
0 005 741	4008057057417	35	45	31	1

Produkte, die sich nicht mehr aktiv in der Vermarktung befinden,
finden Sie auf den folgenden Seiten
On the following pages you will find items
that will not be continued in the future
Vous trouverez les articles en voie de suppression
sur les pages suivantes

Auslaufartikel
Discontinued items
Articles en voie de suppression



Seidenmatt
Silky matt
Satiné

Garderobe
▶ 3 Haken
▶ Edelstahl



Clothes rail
▶ 3 hooks
▶ Stainless steel

Garde-robe
▶ 3 crochets
▶ Acier affiné

Nr./No./Ref.	EAN	↔ mm	↕ mm	↗ mm	VE/PU/Qte
9 101 753	4 008 057 000680	255	140	50	1



Aluminium-Optik
Aluminium look
Aspect aluminium

Hut- und Mantelhaken
▶ Zinkdruckguss

Hat and coat hook
▶ Zinc die-cast

Crochet pour chapeau et manteau
▶ Zamak

Nr./No./Ref.	EAN	↔ mm	↕ mm	↗ mm	VE/PU/Qte
0 014 132	4 008 057 141321	45	80	39	1



1 Nussbaum-Optik / seidenmatt
Walnut look / silky matt
Aspect noyer / satiné

Türhängegarderobe
▶ 4 Haken
▶ Holz / Edelstahl



Door hanger clothes rail
▶ 4 hooks
▶ Wood / stainless steel

Garde-robe à accrocher à la porte
▶ 4 crochets
▶ Bois / acier affiné

Nr./No./Ref.	EAN	mm	↔ mm	↕ mm	↗ mm	VE/PU/Qte
1 9 084 145	4 008 057 856607	16	295	135	66	1
2 9 084 190	4 008 057 856621	16	295	135	66	1

2 Eiche-Optik / seidenmatt
Oak look / silky matt
Aspect chêne / satiné



Aluminium-Optik / Buche, lackiert
Aluminium look / beech, laquered
Aspect aluminium / hêtre, laqué

Hut- und Mantelhaken
▶ Stahl / Holz

Hat and coat hook
▶ Steel / wood

Crochet pour chapeau et manteau
▶ Acier / bois

Nr./No./Ref.	EAN	↔ mm	↕ mm	↗ mm	VE/PU/Qte
0 005 646	4 008 057 056465	49	115	98	1



Aluminium-Optik / Buche, lackiert
Aluminium look / beech, laquered
Aspect aluminium / hêtre, laqué

Hut- und Mantelhaken
▶ Stahl / Holz

Hat and coat hook
▶ Steel / wood

Crochet pour chapeau et manteau
▶ Acier / bois

Nr./No./Ref.	EAN	↔ mm	↕ mm	↗ mm	VE/PU/Qte
0 005 657	4 008 057 056571	49	165	100	1



Mantelhaken
▶ Zinkdruckguss

Coat hook
▶ Zinc die-cast

Crochet pour manteau
▶ Zamak

Vernickelt
Nickel-plated
Nickelé

Nr./No./Ref.	EAN	↔ mm	↕ mm	↗ mm	VE/PU/Qte
0 028 226	4 008 057 282260	75	50	32	1



Mantelhaken
▶ Zinkdruckguss

Coat hook
▶ Zinc die-cast

Crochet pour manteau
▶ Zamak

Weiß
White
Blanc

Nr./No./Ref.	EAN	↔ mm	↕ mm	↗ mm	VE/PU/Qte
0 018 096	4 008 057 180962	72	43	49	1



Hut- und Mantelhaken
▶ Zinkdruckguss

Hat and coat hook
▶ Zinc die-cast

Crochet pour chapeau et manteau
▶ Zamak

1 Braun
Brown
Brun

2 Weiß
White
Blanc

Nr./No./Ref.	EAN	↔ mm	↕ mm	↗ mm	VE/PU/Qte
1 0 018 093	4 008 057 180931	66	108	98	1
2 0 018 095	4 008 057 180955	66	108	98	1



Zierhaken
▶ Zinkdruckguss

Decorative hook
▶ Zinc die-cast

Crochet décoratif
▶ Zamak

1 Weiß
White
Blanc

2 Braun
Brown
Brun

Nr./No./Ref.	EAN	↔ mm	↕ mm	↗ mm	VE/PU/Qte
1 0 018 151	4 008 057 181518	42	35	23	1
2 0 018 150	4 008 057 181501	42	35	23	1



Mantelhaken
▶ Zinkdruckguss

Coat hook
▶ Zinc die-cast

Crochet pour manteau
▶ Zamak

Aluminium-Optik
Aluminium look
Aspect aluminium

Nr./No./Ref.	EAN	↔ mm	↕ mm	↗ mm	VE/PU/Qte
0 014 110	4 008 057 141109	28	28	63	1

Auslaufartikel
Discontinued items
Articles en voie de suppression



Kindergarderobenleiste

- ▶ Löwe
- ▶ 2 Haken
- ▶ Holz

Children's clothes rail

- ▶ Lion
- ▶ 2 hooks
- ▶ Wood

Patère enfants

- ▶ Lion
- ▶ 2 crochets
- ▶ Bois

Mehrfarbig
Multicoloured
Multicoloure

Nr./No./Ref.	EAN	↔ mm	↕ mm	↗ mm	VE/PU/Qte
9 118 197	4008057900041	145	155	65	1



Kindergarderobe

- ▶ Giraffe
- ▶ 1 Haken
- ▶ Holz

Children's clothes rail

- ▶ Giraffe
- ▶ 1 hook
- ▶ Wood

Garde-robe pour enfants

- ▶ Girafe
- ▶ 1 crochet
- ▶ Bois

Orange
Orange
Orange

Nr./No./Ref.	EAN	↔ mm	↕ mm	↗ mm	VE/PU/Qte
9 118 199	4008057900065	85	220	65	1



Kindergarderobenleiste

- ▶ Feuerwehrauto
- ▶ 2 Haken
- ▶ Holz

Children's clothes rail

- ▶ Fire engine
- ▶ 2 hooks
- ▶ Wood

Patère enfants

- ▶ Voiture des pompiers
- ▶ 2 crochets
- ▶ Bois

Rot
Rot
Rot

Nr./No./Ref.	EAN	↔ mm	↕ mm	↗ mm	VE/PU/Qte
9 118 212	4008057900096	180	110	70	1



Kindergarderobe

- ▶ Fußball
- ▶ 1 Haken
- ▶ Holz

Children's clothes rail

- ▶ Football
- ▶ 1 hook
- ▶ Wood

Garde-robe pour enfants

- ▶ Football
- ▶ 1 crochet
- ▶ Bois

Schwarz / weiß
Black / white
Noir / blanc

Nr./No./Ref.	EAN	↔ mm	↕ mm	↗ mm	VE/PU/Qte
9 118 217	4008057900126	120	120	60	1



Kindergarderobenleiste

- ▶ Fußball
- ▶ 3 Haken
- ▶ Holz

Children's clothes rail

- ▶ Football
- ▶ 3 hooks
- ▶ Wood

Patère enfants

- ▶ Football
- ▶ 3 crochets
- ▶ Bois

Schwarz / weiß
Black / white
Noir / blanc

Nr./No./Ref.	EAN	↔ mm	↕ mm	↗ mm	VE/PU/Qte
9 118 213	4008057900102	360	120	60	1



Kindergarderobe

- ▶ Blume
- ▶ 1 Haken
- ▶ Holz

Children's clothes rail

- ▶ Flower
- ▶ 1 hook
- ▶ Wood

Garde-robe pour enfants

- ▶ Fleur
- ▶ 1 crochet
- ▶ Bois

Mehrfarbig
Multicoloured
Multicoloure

Nr./No./Ref.	EAN	↔ mm	↕ mm	↗ mm	VE/PU/Qte
9 118 233	4008057900171	130	120	60	1



Kindergarderobe

- ▶ Herz
- ▶ 1 Haken
- ▶ Holz

Children's clothes rail

- ▶ Heart
- ▶ 1 hook
- ▶ Wood

Garde-robe pour enfants

- ▶ Cœur
- ▶ 1 crochet
- ▶ Bois

1 Rosa
Rose
Rose

2 Pink
Pink
Fuchsia



Nr./No./Ref.	EAN	↔ mm	↕ mm	↗ mm	VE/PU/Qte
1 9 118 231	4008057900157	125	110	60	1
2 9 118 232	4008057900164	125	110	60	1



Kindergarderobe

- ▶ Stern
- ▶ 1 Haken
- ▶ Holz

Children's clothes rail

- ▶ Star
- ▶ 1 hook
- ▶ Wood

Garde-robe pour enfants

- ▶ Étoile
- ▶ 1 crochet
- ▶ Bois

Lila / weiß
Mauve / white
Violet / blanc

Nr./No./Ref.	EAN	↔ mm	↕ mm	↗ mm	VE/PU/Qte
9 118 234	4008057900188	120	120	60	1



Hut- und Mantelhaken

- ▶ Kunststoff

Hat and coat hook

- ▶ Plastic

Crochet pour chapeau et manteau

- ▶ Plastique

Blau
Blue
Bleu

Nr./No./Ref.	EAN	↔ mm	↕ mm	↗ mm	VE/PU/Qte
0 005 683	4008057056830	56	150	70	1



Garderobenleiste

- ▶ 2 Haken
- ▶ Kunststoff

Clothes rail

- ▶ 2 hooks
- ▶ Plastic

Patère

- ▶ 2 crochets
- ▶ Plastique

1 Blau
Blue
Bleu

2 Dreifarbig
Three coloured
À trois couleurs



Nr./No./Ref.	EAN	↔ mm	↕ mm	↗ mm	VE/PU/Qte
1 0 005 967	4008057059671	163	150	70	1
2 0 005 983	4008057059831	163	150	70	1



Zierhaken

- ▶ Zinkdruckguss

Decorative hook

- ▶ Zinc die-cast

Crochet décoratif

- ▶ Zamak

Aluminium-Optik
Aluminium look
Aspect aluminium

Nr./No./Ref.	EAN	↔ mm	↕ mm	↗ mm	VE/PU/Qte
0 018 149	4008057181495	49	49	27	1

Auslaufartikel
Discontinued items
Articles en voie de suppression



Garderobenhaken
▶ Kunststoff

Clothes hook
▶ Plastic

Crochet de garde-robe
▶ Plastique

Nr./No./Ref.	EAN	↔ mm	↕ mm	↗ mm	VE/PU/Qte
0 060 508	40080571605083	62	90	65	1

Silberfarben
Silver coloured
Teinté argent



Garderobenleiste
▶ 2 Haken
▶ Kunststoff

Clothes rail
▶ 2 hooks
▶ Plastic

Patère
▶ 2 crochets
▶ Plastique

Nr./No./Ref.	EAN	↔ mm	↕ mm	↗ mm	VE/PU/Qte
0 060 509	40080571605090	250	90	65	1

Silberfarben
Silver coloured
Teinté argent



Garderobenleiste
▶ 3 Haken
▶ Kunststoff

Clothes rail
▶ 3 hooks
▶ Plastic

Patère
▶ 3 crochets
▶ Plastique

Nr./No./Ref.	EAN	↔ mm	↕ mm	↗ mm	VE/PU/Qte
1 0 060 510	40080571605106	360	105	65	1

Silberfarben
Silver coloured
Teinté argent



Hut- und Mantelhaken
▶ Zinkdruckguss

Hat and coat hook
▶ Zinc die-cast

Crochet pour chapeau et manteau
▶ Zamak

Nr./No./Ref.	EAN	↔ mm	↕ mm	↗ mm	VE/PU/Qte
0 028 225	40080571282253	76	96	90	1

Vernickelt
Nickel-plated
Nickleé



Mantelhaken
▶ Zinkdruckguss

Coat hook
▶ Zinc die-cast

Crochet pour manteau
▶ Zamak

Nr./No./Ref.	EAN	↔ mm	↕ mm	↗ mm	VE/PU/Qte
0 040 004	40080571400046	58	31	29	1

Aluminium-Optik
Aluminium look
Aspect aluminium

Artikelnummernverzeichnis
Order number index
Références des articles

Artikelnummernverzeichnis
Order number index
Références des articles

Artikel-Nr. Order no. Référence	Seite Page Page	Artikel-Nr. Order no. Référence	Seite Page Page	Artikel-Nr. Order no. Référence	Seite Page Page	Artikel-Nr. Order no. Référence	Seite Page Page	Artikel-Nr. Order no. Référence	Seite Page Page	Artikel-Nr. Order no. Référence	Seite Page Page
0 002 309	116	0 005 650	98	0 015 682	95	9 082 152	20	9 157 279	22	9 193 772	26
0 003 436	14	0 005 651	98	0 015 767	50	9 084 144	83	9 157 280	22	9 193 779	24
0 003 639	64	0 005 652	98	0 015 768	50	9 084 145	118	9 157 933	41	9 193 780	23
0 003 679	22	0 005 657	118	0 015 802	90	9 084 189	82	9 157 934	41	9 193 793	22
0 003 710	44	0 005 681	112	0 015 803	90	9 084 190	118	9 157 935	40	9 193 795	23
0 004 022	44	0 005 682	112	0 015 805	90	9 084 191	82	9 157 937	40	9 193 796	24
0 004 044	63	0 005 683	121	0 015 809	90	9 084 192	83	9 158 096	20	9 193 797	24
0 004 045	63	0 005 710	98	0 015 810	90	9 084 193	109	9 158 100	25	9 193 798	22
0 004 046	63	0 005 711	98	0 015 814	115	9 084 194	109	9 158 101	17	9 193 799	23
0 004 047	63	0 005 712	98	0 015 820	102	9 084 195	109	9 158 580	38	9 193 800	23
0 004 048	63	0 005 713	98	0 015 821	102	9 086 122	28	9 158 581	38	9 196 367	24
0 004 049	63	0 005 741	116	0 015 825	105	9 086 123	28	9 158 582	38	9 196 368	19
0 004 050	63	0 005 894	98	0 015 826	105	9 100 310	49	9 158 583	37	9 196 369	24
0 004 051	63	0 005 962	112	0 015 968	46	9 100 384	49	9 158 584	37	9 196 370	26
0 004 075	44	0 005 963	112	0 015 969	46	9 100 389	63	9 158 585	37	9 196 384	23
0 004 076	44	0 005 965	112	0 015 980	18	9 100 390	49	9 158 586	37	9 196 385	19
0 004 077	44	0 005 966	112	0 015 981	51	9 100 418	63	9 158 587	41	9 196 386	19
0 004 078	44	0 005 967	121	0 015 982	51	9 101 751	74	9 158 588	41	9 196 387	19
0 004 079	44	0 005 983	121	0 015 983	51	9 101 752	74	9 158 589	38	9 196 388	22
0 004 080	44	0 005 984	112	0 015 984	18	9 101 753	118	9 158 590	54	9 196 389	16
0 004 101	44	0 005 985	112	0 015 985	51	9 101 754	74	9 158 591	54	9 196 390	15
0 004 183	64	0 005 986	112	0 015 986	51	9 101 755	74	9 158 592	54	9 196 391	15
0 004 197	64	0 005 990	106	0 015 987	51	9 101 756	75	9 158 593	41	9 196 392	16
0 004 199	64	0 005 995	103	0 016 194	94	9 101 757	75	9 158 594	39	9 196 393	15
0 004 202	64	0 005 996	103	0 016 196	94	9 101 758	77	9 158 595	39	9 196 394	15
0 004 272	94	0 006 000	93	0 018 093	119	9 101 759	77	9 158 596	40	9 196 395	16
0 004 274	95	0 006 001	93	0 018 094	101	9 101 760	75	9 158 597	40	9 196 396	15
0 004 314	34	0 006 003	93	0 018 095	119	9 101 761	75	9 158 598	40	9 196 397	16
0 004 406	113	0 006 004	93	0 018 096	119	9 101 762	75	9 158 599	40	9 196 398	23
0 004 407	113	0 006 032	93	0 018 097	64	9 101 763	75	9 158 600	39	9 196 399	22
0 004 409	101	0 007 150	32	0 018 148	116	9 102 511	18	9 158 601	39	9 196 400	16
0 004 411	101	0 007 152	32	0 018 149	121	9 102 512	18	9 158 602	39	9 196 411	16
0 004 412	101	0 007 175	32	0 018 150	119	9 112 704	114	9 158 603	39	9 196 412	16
0 004 418	113	0 007 600	67	0 018 151	119	9 112 706	114	9 158 604	40	9 196 413	16
0 004 419	113	0 007 601	67	0 018 152	102	9 113 120	52	9 158 605	40	9 196 414	15
0 004 422	113	0 007 602	67	0 024 012	41	9 118 197	120	9 158 606	40	9 196 415	16
0 004 852	88	0 007 616	14	0 024 600	27	9 118 199	120	9 158 607	40	9 196 416	16
0 004 853	88	0 007 617	14	0 028 225	122	9 118 212	120	9 158 608	41	9 196 444	79
0 004 854	86	0 007 621	15	0 028 226	119	9 118 213	120	9 158 609	35	9 196 449	79
0 004 855	86	0 012 693	113	0 040 001	79	9 118 217	120	9 158 610	35	9 196 450	79
0 004 856	88	0 012 697	113	0 040 002	79	9 118 231	121	9 158 611	35	9 196 452	27
0 004 857	87	0 012 699	114	0 040 003	81	9 118 232	121	9 158 612	35	9 196 454	29
0 004 868	86	0 012 923	113	0 040 004	122	9 118 233	120	9 158 613	35	9 196 455	29
0 004 869	86	0 014 109	105	0 040 011	103	9 118 234	121	9 158 614	35	9 196 456	29
0 004 870	88	0 014 110	119	0 040 012	103	9 126 436	66	9 158 615	35	9 196 477	24
0 004 871	87	0 014 120	80	0 040 013	78	9 126 437	66	9 158 616	35	9 196 478	24
0 004 872	90	0 014 121	51	0 040 014	78	9 130 579	63	9 158 617	35	9 196 479	26
0 004 879	86	0 014 123	106	0 040 015	78	9 130 580	63	9 158 618	35	9 196 480	52
0 004 880	88	0 014 125	106	0 047 154	94	9 137 427	108	9 158 619	36	9 196 491	52
0 004 881	87	0 014 128	45	0 047 155	77	9 137 485	109	9 158 620	36	9 196 492	29
0 004 900	115	0 014 130	81	0 047 156	77	9 150 411	62	9 158 621	36	9 196 493	29
0 004 907	115	0 014 131	81	0 049 827	77	9 150 429	62	9 158 622	36	9 196 494	29
0 004 908	115	0 014 132	118	0 060 501	83	9 150 440	49	9 161 863	26	9 196 495	30
0 004 909	115	0 014 137	101	0 060 502	76	9 150 483	50	9 162 886	14	9 196 496	29
0 004 912	115	0 014 148	18	0 060 503	76	9 150 504	50	9 162 887	14	9 196 497	29
0 004 925	88	0 014 155	47	0 060 504	76	9 150 510	34	9 163 233	47	9 196 498	30
0 004 926	88	0 014 156	47	0 060 505	76	9 150 541	46	9 163 239	47	9 196 499	30
0 004 966	88	0 014 173	81	0 060 506	76	9 150 561	18	9 180 267	18	9 196 500	46
0 004 967	88	0 014 175	80	0 060 507	76	9 150 608	48	9 184 215	17	9 196 501	46
0 004 983	100	0 014 178	80	0 060 508	122	9 150 617	18	9 184 221	17	9 196 502	46
0 004 984	100	0 015 603	32	0 060 509	122	9 153 521	18	9 184 224	27	9 196 503	46
0 004 997	115	0 015 605	32	0 060 510	122	9 157 245	26	9 184 239	63	9 196 504	46
0 005 642	80	0 015 611	32	0 060 517	94	9 157 246	26	9 184 704	17	9 196 505	46
0 005 645	103	0 015 612	32	9 082 150	20	9 157 247	30	9 193 751	36	9 196 506	14
0 005 646	118	0 015 616	32	9 082 151	20	9 157 278	22	9 193 752	36	9 196 507	14

Artikel-Nr. Order no. Référence	Seite Page Page	Artikel-Nr. Order no. Référence	Seite Page Page	Artikel-Nr. Order no. Référence	Seite Page Page	Artikel-Nr. Order no. Référence	Seite Page Page	Artikel-Nr. Order no. Référence	Seite Page Page	Artikel-Nr. Order no. Référence	Seite Page Page
9 196 508	14	9 202 457	16	9 207 847	45	9 207 913	115	9 208 229	54	9 211 317	67
9 196 509	44	9 202 458	16	9 207 848	45	9 207 914	100	9 208 230	56	9 211 320	67
9 196 510	44	9 202 459	16	9 207 849	15	9 207 915	100	9 208 231	55	9 211 321	67
9 196 511	44	9 202 460	16	9 207 850	50	9 207 916	102	9 208 232	56	9 211 322	49
9 196 512	45	9 202 461	25	9 207 851	50	9 207 917	102	9 208 233	57	9 211 323	49
9 196 513	45	9 202 462	25	9 207 852	49	9 207 918	100	9 208 234	56	9 211 324	49
9 196 514	23	9 202 463	25	9 207 853	49	9 207 919	102	9 208 235	56	9 211 874	28
9 196 954	46	9 202 464	25	9 207 854	50	9 207 920	102	9 208 236	56	9 211 878	28
9 196 955	46	9 202 492	63	9 207 855	49	9 207 921	81	9 208 238	55	9 211 879	28
9 196 956	27	9 203 224	64	9 207 856	52	9 207 922	102	9 208 239	55	9 211 880	44
9 196 957	20	9 203 237	64	9 207 857	52	9 207 923	99	9 208 240	55	9 211 881	44
9 196 958	46	9 203 238	64	9 207 858	34	9 207 924	99	9 208 241	55	9 211 882	25
9 196 959	46	9 203 239	64	9 207 859	27	9 207 925	99	9 208 242	55	9 211 884	16
9 196 960	20	9 203 240	64	9 207 860	50	9 207 926	104	9 208 243	55	9 211 885	16
9 196 991	20	9 203 241	64	9 207 861	52	9 207 927	104	9 208 449	46	9 211 886	16
9 196 992	20	9 203 242	64	9 207 862	52	9 207 938	99	9 208 450	46	9 211 916	109
9 196 993	20	9 203 243	64	9 207 863	51	9 207 939	89	9 208 451	46	9 211 917	58
9 196 994	17	9 203 244	64	9 207 864	51	9 207 940	79	9 208 452	46	9 211 928	58
9 196 995	17	9 203 257	64	9 207 865	19	9 207 941	103	9 208 453	47	9 211 929	58
9 196 996	14	9 203 259	64	9 207 866	47	9 207 942	79	9 208 454	47	9 211 930	58
9 196 997	17	9 203 260	64	9 207 867	47	9 207 943	99	9 208 455	47	9 211 931	58
9 196 998	17	9 203 262	65	9 207 868	48	9 207 944	89	9 208 456	47	9 211 932	82
9 196 999	14	9 203 298	65	9 207 869	62	9 207 945	89	9 208 457	62	9 211 934	82
9 197 000	20	9 203 299	65	9 207 870	45	9 207 946	80	9 208 468	62	9 211 935	82
9 197 001	27	9 203 300	65	9 207 871	45	9 207 948	89	9 208 469	62	9 211 936	94
9 197 002	51	9 203 301	65	9 207 872	48	9 207 949	80	9 208 470	62	9 215 083	104
9 197 003	50	9 203 302	66	9 207 873	45	9 207 950	87	9 208 471	25	9 215 084	104
9 197 004	50	9 203 303	66	9 207 874	62	9 207 951	87	9 208 472	29	9 215 085	104
9 197 005	24	9 203 304	66	9 207 875	47	9 207 952	87	9 208 473	17	9 215 086	104
9 197 006	25	9 203 305	65	9 207 876	48	9 207 953	87	9 208 474	17	9 215 087	104
9 197 007	28	9 203 306	65	9 207 877	15	9 207 954	89	9 208 475	17	9 215 088	104
9 197 008	25	9 203 308	65	9 207 878	47	9 207 956	99	9 208 476	36	9 215 089	105
9 197 009	25	9 203 309	65	9 207 879	62	9 207 960	99	9 208 479	36	9 215 090	105
9 197 010	25	9 203 310	66	9 207 880	48	9 207 962	99	9 208 480	36	9 215 091	105
9 197 011	51	9 203 311	66	9 207 881	51	9 207 964	102	9 208 481	20	9 215 092	105
9 197 012	51	9 203 453	65	9 207 882	47	9 207 965	102	9 208 482	20	9 215 093	105
9 197 013	25	9 204 223	34	9 207 883	45	9 207 966	102	9 208 484	28	9 215 094	105
9 197 014	20	9 204 245	33	9 207 884	45	9 207 967	99	9 208 485	28	9 215 095	104
9 199 022	17	9 204 246	33	9 207 885	45	9 207 968	101	9 208 486	19	9 215 096	104
9 199 023	17	9 204 248	33	9 207 886	45	9 207 969	101	9 208 487	51	9 215 097	23
9 199 024	114	9 204 250	33	9 207 887	45	9 207 970	101	9 208 488	19	9 215 098	26
9 199 025	114	9 204 251	33	9 207 888	18	9 207 971	101	9 208 489	19	9 215 099	30
9 199 026	114	9 204 252	33	9 207 889	18	9 207 972	99	9 208 491	37	9 215 100	30
9 202 428	48	9 204 253	33	9 207 890	18	9 207 973	87	9 208 492	38	9 216 145	92
9 202 429	48	9 204 254	34	9 207 891	18	9 207 974	87	9 208 493	38	9 216 146	92
9 202 430	48	9 207 827	46	9 207 892	16	9 207 975	87	9 208 494	37	9 216 167	92
9 202 431	48	9 207 828	46	9 207 893	16	9 207 976	87	9 208 495	38	9 216 168	92
9 202 432	14	9 207 829	46	9 207 894	16	9 207 977	102	9 208 496	41	9 216 169	92
9 202 434	48	9 207 830	46	9 207 895	14	9 207 978	78	9 208 497	42	9 216 171	93
9 202 435	48	9 207 831	34	9 207 896	14	9 207 979	78	9 208 498	37	9 217 258	77
9 202 436	48	9 207 832	34	9 207 897	15	9 207 980	78	9 208 499	38	9 220 832	108
9 202 437	48	9 207 833	14	9 207 898	15	9 208 195	57	9 208 500	37	9 220 835	108
9 202 438	62	9 207 834	14	9 207 899	15	9 208 196	54	9 208 501	41	9 220 836	108
9 202 439	62	9 207 835	15	9 207 900	14	9 208 197	54	9 208 502	41	9 220 837	108
9 202 440	62	9 207 836	45	9 207 901	65	9 208 218	54	9 208 503	38	9 220 838	71
9 202 441	62	9 207 837	45	9 207 902	65	9 208 219	55	9 208 504	37	9 220 839	92
9 202 442	62	9 207 838	48	9 207 903	66	9 208 220	54	9 209 266	17	9 220 840	86
9 202 443	62	9 207 839	17	9 207 904	79	9 208 221	55	9 211 147	59	9 220 841	108
9 202 444	62	9 207 840	15	9 207 905	100	9 208 222	56	9 211 168	59	9 220 842	86
9 202 445	62	9 207 841	15	9 207 906	100	9 208 223	57	9 211 169	59	9 220 843	108
9 202 446	62	9 207 842	17	9 207 907	100	9 208 224	57	9 211 170	58	9 220 844	108
9 202 447	62	9 207 843	30	9 207 908	90	9 208 225	57	9 211 171	59	9 220 845	86
9 202 448	62	9 207 844	30	9 207 909	89	9 208 226	57	9 211 172	59	9 220 846	74
9 202 449	62	9 207 845	45	9 207 910	81	9 208 227	54	9 211 303	67	9 220 848	74
9 202 454	46	9 207 846	45	9 207 911	115	9 208 228	55	9 211 315	67		

Technische Rahmenbedingungen

Die in diesem Katalog enthaltenen Verarbeitungshinweise, Anschraubbilder und Belastungsangaben beziehen sich auf eine fachgerechte Befestigung.

Bei Verwendung anderer Materialien oder anderer Befestigungsarten übernimmt Hettich keine Gewähr für die Belastbarkeit des Möbels und seiner Komponenten; die Belastbarkeit ist vom Möbelhersteller zu prüfen.

Die im Katalog dargestellten Einbausituationen dienen nur zur Darstellung der möglichen Varianten. Die normgerechte Auslegung der Möbel, insbesondere die Einhaltung der Sicherheitsanforderungen, obliegt dem Möbelhersteller. Für weitere Informationen stehen wir Ihnen gerne zur Verfügung.

Für diesen Katalog behalten wir uns alle Rechte aus dem Urheberrecht vor. Ohne unsere Genehmigung ist es nicht gestattet, den Katalog oder Teile daraus in irgendeiner Form zu vervielfältigen. Technische Änderungen vorbehalten. Keine Gewährleistung für Druckfehler oder Irrtümer. Farbabweichungen vorbehalten.

General technical conditions

The fitting instructions, screw-fixing points and load-bearing information given in this catalogue assume proper attachment.

Hettich accepts no responsibility for the use of materials or methods of attachment other than those stated. If other materials or methods of attachment are used, the furniture manufacturer is required to verify the system's load-bearing capacity.

The fitting situations shown in this catalogue are only intended to illustrate the possible options. The furniture manufacturer is responsible for ensuring that furniture is designed in compliance with safety requirements defined in the applicable standards. We will be pleased to provide any further information you may require.

We reserve all rights to this catalogue under copyright law. It shall not be permissible to duplicate this catalogue in any form either in whole or in part without our written consent. Subject to technical alterations. Errors and omissions excepted. Subject to colour variations

Cadre technique





Les consignes de mise en œuvre, configurations de perçage et indications de résistance aux charges figurant dans le présent catalogue se réfèrent à une fixation correcte.

En cas d'utilisation d'autres matériaux ou types de fixation, Hettich n'assume aucune garantie et la résistance aux charges du système doit être vérifiée par le fabricant de meubles

Les situations d'installation représentées dans le catalogue servent uniquement à la représentation de variantes possibles. La conception normalisée des meubles, particulièrement en ce qui concerne les exigences de sécurité, sont du ressort du constructeur de meubles. Si vous avez besoin de plus amples informations, nous nous tenons volontiers à votre entière disposition.

Tous droits d'auteur réservés pour le présent catalogue. La reproduction de tout ou partie du catalogue, quels qu'en soient les moyens, est interdite sans autorisation de notre part. Sous réserve de modifications techniques. Aucune garantie pour les coquilles ou les erreurs. Sous réserve de différences de couleurs

Bildnachweise / picture credits / justificatifs des photos

Seite / page / page				
5	enterlinedesign / Shutterstock.com			
Seite / page / page				
13, 73	-	virtua73 / Fotolia	arsdigital / Fotolia	zho difeng / Fotolia
21, 85	Andy Dean / Fotolia	-	Marina / Fotolia	Friedberg / Fotolia
31, 91	Iriana Shiyan / Fotolia	Smileus / Fotolia	-	imnoom / Fotolia
43, 97	Ekaterian Pokrovsky / Fotolia	lulu / Fotolia	Mihalis A. / Fotolia	-
53, 107	Dmitry Koksharov / Fotolia	drubig-photo / Fotolia	-	Krissu / Fotolia
61, 111	Robert Kneschke / Shutterstock.com	-	annabel2012 / Fotolia	Robert Kneschke / Fotolia

Verpackungsarten

Packaging types

Types d'emballage



Aufhängelasche
Hanger
Patte d'accrochage



Blisterbox
Blister box
Boîte blister



Lose
Loose
En vrac



Pappkarte
Card
Plaque en carton



Polybeutel mit Etikett
Polythene bag with label
Sachet en polyéthylène avec étiquette



Polybeutel mit Eurolochung
Polythene bag with Euro hole
Sachet en polyéthylène avec perforation européenne



Polybeutel mit Pappreiter
Polythene bag with header card
Sachet en polyéthylène avec carte à accrocher

Piktogramme

Pictograms

Pictogrammes



Höhe
Height
Hautuer



Breite
Width
Largeur



Länge / Tiefe
Length / depth
Longueur / profondeur



Durchmesser außen
External diameter
Diamètre extérieur



Durchmesser innen
Internal diameter
Diamètre intérieur



Lochabstand
Hole spacing
Ecartement entraxes



Auflagefläche
Support area
Surface d'appui



Türstärke Glas
Glass door thickness
Épaisseur de porte en verre



Unterbaumontage
Base frame mounting
Montage sous châssis



zum Aufschrauben
Screw-on
À visser



Massiv Messing
Pure brass
Laiton pur



Edelstahl rostfrei
Stainless steel
Acier inoxydable

Modern 013 - 020

Antik & Retro 021 - 030

Country 031 - 042

Classic 043 - 052

Colours & Kids 053 - 060

BUDGET 061 - 068

Garderoben & Haken / Clothes rails & hooks / Garde-robres & crochets

Modern 073 - 084

Antik & Retro 085 - 090

Country 091 - 096

Classic 097 - 106

Colours & Kids 107 - 110

BUDGET 111 - 116

Auslaufartikel
Discontinued items
Fin de série 117 - 122

Artikelnummernverzeichnis
Order number index
Références des articles / cadre technique 123 - 125



www.hettich-diy.com

923356700
1. Auflage / 1. Edition 02/2017

© Hettich Do-It-Yourself GmbH & Co. KG
Technische Änderungen vorbehalten.
Keine Gewährleistung für Druckfehler oder Irrtümer.
Subject to change without notice. Errors and omissions excepted.
Sous réserve de modifications techniques.
Nous déclinons toute responsabilité pour les fautes d'impression ou les erreurs.

Technik für Möbel

